



## ARCHITECTURAL CAMPUS PLANNING PRINCIPLES

### INTRODUCTION

The purpose of this section of the master plan document is to form a basis for the architectural character, composition, and typology of future buildings, groups of buildings and exterior spaces on the University of Georgia campus. This portion of the document aspires to be both a "mirror" and a "lamp." The buildings already existent on the Athens campus were observed, documented, and analyzed in the course of preparation of this study. Thus, the suggestions for future architectural interventions made herein attempt to reflect the best architectural traditions evident on campus.

While many aspects of the University of Georgia's campus make it one of the most memorable compositions of buildings and open spaces to be found in the nation, it is not the purpose of this document to replicate the historic core in order to create a new architecture of empty nostalgia. The University of Georgia campus forms a collection of buildings from many different time periods and of various styles. There is not a unique "University of Georgia style" per se, rather the notable buildings built over the course of time, reflect both the needs of the moment and the traditions of architecture compatible with the context of the Athens campus.

It is hoped that the insights gleaned from a reading of this section will enable the campus community to better recognize and understand the architectural traditions of the campus, while simultaneously forming a touchstone for architects, landscape architects, planners, and other design working on future projects. Since innovation is always understood relative to some context, the traditions suggested by this portion of the document are intended to "light the way" for future projects.



## EXISTING UGA BUILDING STYLES VERNACULAR/GEORGIAN/NEO-CLASSICAL

Below are examples of Georgian, Federal and Greek Revival building styles found on the UGA campus and a brief indication of their characteristics.

### Examples

- Old College
- New College
- Phi Kappa Hall
- Chapel
- Demosthenian Hall

### Observations

- Domestic scale – unassuming character with exception of the Chapel
- Generally more wall than window
- Visual tension between proportions of opening and wall (i.e., the proportions of the wall are often more dominant than the proportions of window)
- Architectural elements are often integral to the building's construction
- Vertical bay structure and vertically oriented openings
- Spartan vocabulary, restrained use of ornament
- Pragmatic elements modulate facade (e.g., downspout, chimneys, entrances)
- Facade is not overly "deep" except when a portico element is added to recognize entry
- 

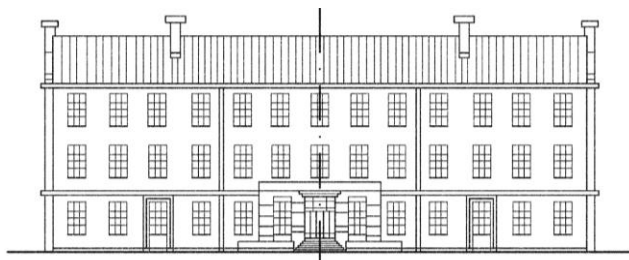

Old College

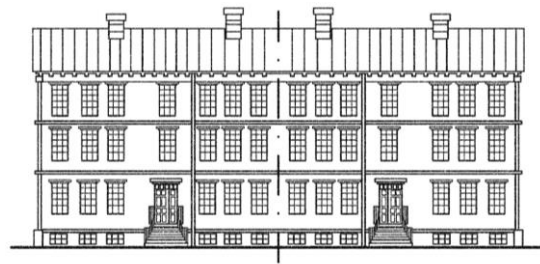

New College

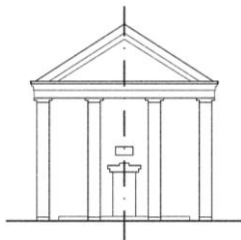

Phi Kappa Hall

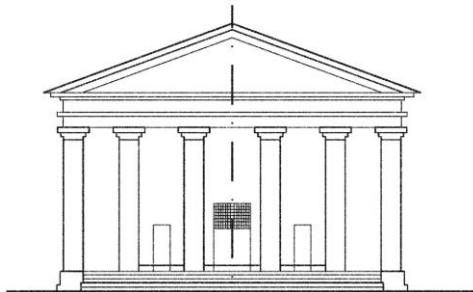

Chapel

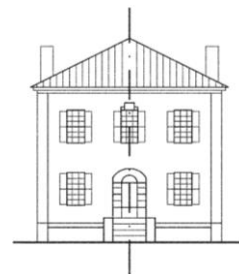

Demosthenian Hall



## EXISTING UGA BUILDING STYLES BEAUX-ARTS

Below are some examples of Beaux-Arts building styles found on the UGA campus and a brief indication of their characteristics.

### Examples

- Peabody Hall
- Memorial Hall
- Business School

### Observations

- Monumental scale compatible with domestic core of campus
- Range of proportion of window to wall
- System of ornamentation may not be directly tied to constructional technique, rather it is tied to broader cultural ideals related to building type (i.e., you know it is a “library” by its appearance, but what you see may or may not directly be related to how it was built)
- Use of sophisticated proportioning systems
- Division into 3 parts vertically and horizontally – clear hierarchy of parts
- Facade is “sculpted” in 3 dimensions as if carved from a block of clay
- Preference for symmetry, however complex overlapping local symmetries are sometimes used to produce localized picturesque effects
- Generally incorporates historical references

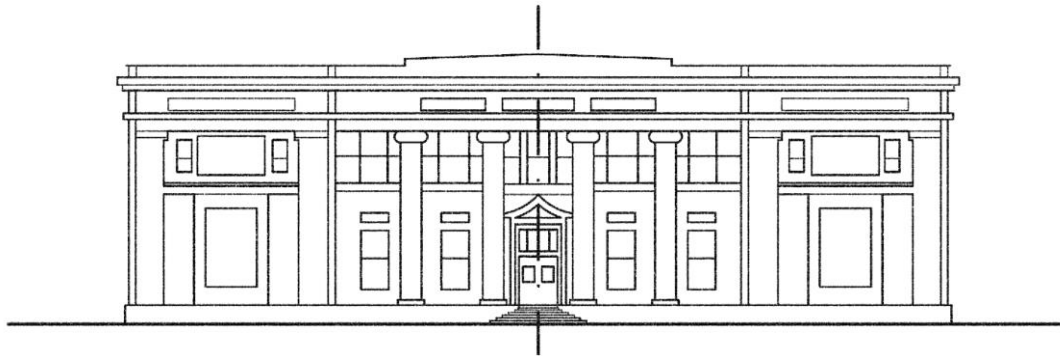

Peabody Hall

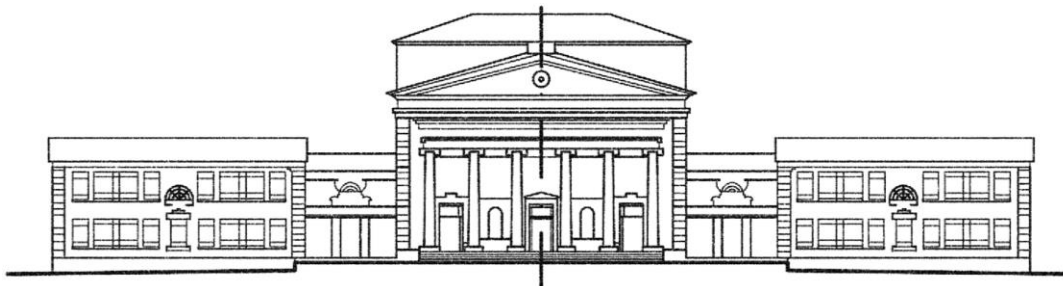

Fine Arts Building



## EXISTING UGA BUILDING STYLES MODERN AND TRADITIONAL

Below are some examples of Modern and Traditional building styles found on the UGA campus and a brief indication of their characteristics.

### Examples

- Library
- Fine Arts Building Additions
- Sanford Hall

### Observations

- A more monumental scale
- Recognition of frame construction techniques in aesthetic of vertical surface
- Often more window than wall or an equivalent proportion of window and wall
- Facade is “layered” as a series of flat, planar surfaces composed within the constraints of a modest dimension.
- System of ornamentation is restrained, however attempts to relate constructional techniques to cultural ideals related to building type (i.e., you know it is a “library” by its appearance, and you have an idea of how it was built)
- Draws inspiration from history and ideas of contemporary life

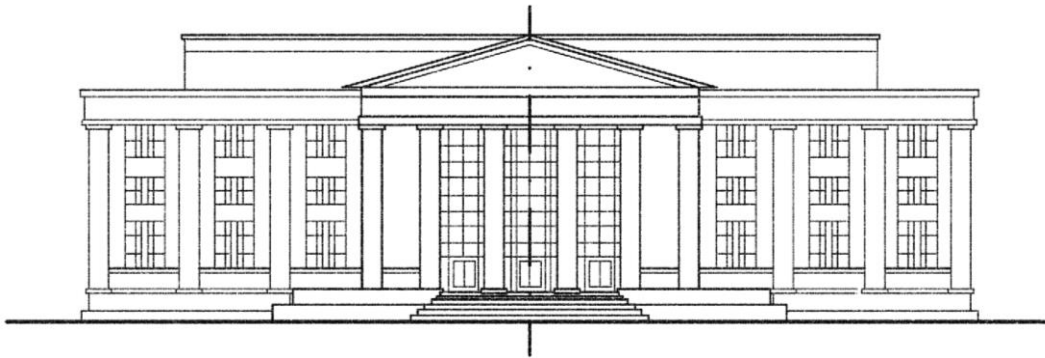

Main Library



## EXISTING UGA BUILDING STYLES MODERN AND CONTEMPORARY

Below are some examples of Modern and Contemporary building styles found on the UGA campus and a brief indication of their characteristics.

### Examples

- Chemistry Annex
- Georgia Museum of Art

### Observations

- Vertical surfaces are less likely to be designed as “facades”<sup>[SEP]</sup>
- Overall massing dictates form – buildings less likely to participate in campus space making
- Openings are “slots” or “zones” where wall surface is omitted rather than an incised opening
- Character of building is particular to the whim of the architect, client, or donor<sup>[SEP]</sup>
- Building does not necessarily communicate an idea of what it is or how it was built
- Unclear hierarchy of parts
- Scale is indeterminate
- Abstract form preferred over forms of “traditional building” (i.e., roofs, walls, doors, windows, are replaced with horizontal planes, vertical planes, and various kinds of apertures)
- Preference for asymmetrical massing and the picturesque over symmetry
- Notion of the Zeitgeist prevails, history and tradition are devalued – draws little upon immediate physical context



Chemistry Annex



Georgia Museum of Art



## THE APPLICATION OF AMERICAN CAMPUS PLANNING PRINCIPLES TO THE UNIVERSITY OF GEORGIA

The planning principles exhibited on American campuses are truly a unique art form. While the traditions of campus planning in the United States are closely related to attitudes concerning building and the landscape developed between the 16th and 19th centuries in England, France, and Italy, the application of these principles to the built form of the university is an art form, which evolved principally in this country. The close relationship between built form and the landscape is a characteristic of campus planning that is the taproot of this art form. From Thomas Jefferson's University of Virginia, to Saarenin's Cranbrook Academy, this tradition remained unbroken until the Second World War.

One of the most readily identifiable characteristics of this tradition was the creation of exterior spaces, which could be likened to interior rooms. In the diagram illustrated in Figure 1, a prototypical room is drawn alongside a university quadrangle of similar proportions. Nearly everyone is familiar with the sense of enclosure and protection afforded by a room's bounding surfaces – walls enclose space; windows admit light and air while permitting views to the exterior world; doors permit access; and typically there is some element of focus within the room, perhaps a hearth. It is readily evident that every element performs a role supporting the larger notion of "room." That is, walls alone do not the room make. The interdependency of elements and the specialized tasks they play relegate elements of the room to hierarchical roles in the overall composition. That is a door to the room will serve to frame a view of the room's principal feature – the hearth, and all along the corners of the room will be subservient to both the former and later elements.

Likewise, the exterior room of a campus quadrangle has features, which might be seen as analogous to that of a traditional interior room. The library may dominate the composition in much the same manner as the hearth, while a pair of buildings axially disposed across the quadrangle from this principal feature might serve the same threshold purposes as that of a door. One might readily see that a successful composition of a college quadrangle requires that the buildings operate in concert with one another. Sometimes buildings are called upon to play more assertive roles that of a "hero," like the library, or the matching buildings forming the campus threshold. The heroic buildings, however, require substantial amounts of good "soldier" buildings to form the backdrop against which these more assertive buildings might be seen.

In planning and building a new campus or on a portion of an existing campus it is very important to understand the role that individual buildings are required to play. Too many heroic structures would be like a room full of guests all talking at the same time. Too few heroic buildings would be like a party where none of the guests ever arrived – a bit of a bore. In planning a successful campus composition, one seeks to strike a balance between the "heroes" and the "soldiers." Experience has shown that every trustee, donor, president, dean, every department chair, or faculty member, usually like to view their "new building" as aspiring to be a "hero." And, while much might be said of the heroic nature of the common foot soldier, it is recommended that the creation of heroic buildings on college campuses be limited to those building types which embody and relate the most universal and lofty aspirations of the entire institution – churches, libraries, places of assembly, etc.





Main Library



Main Library

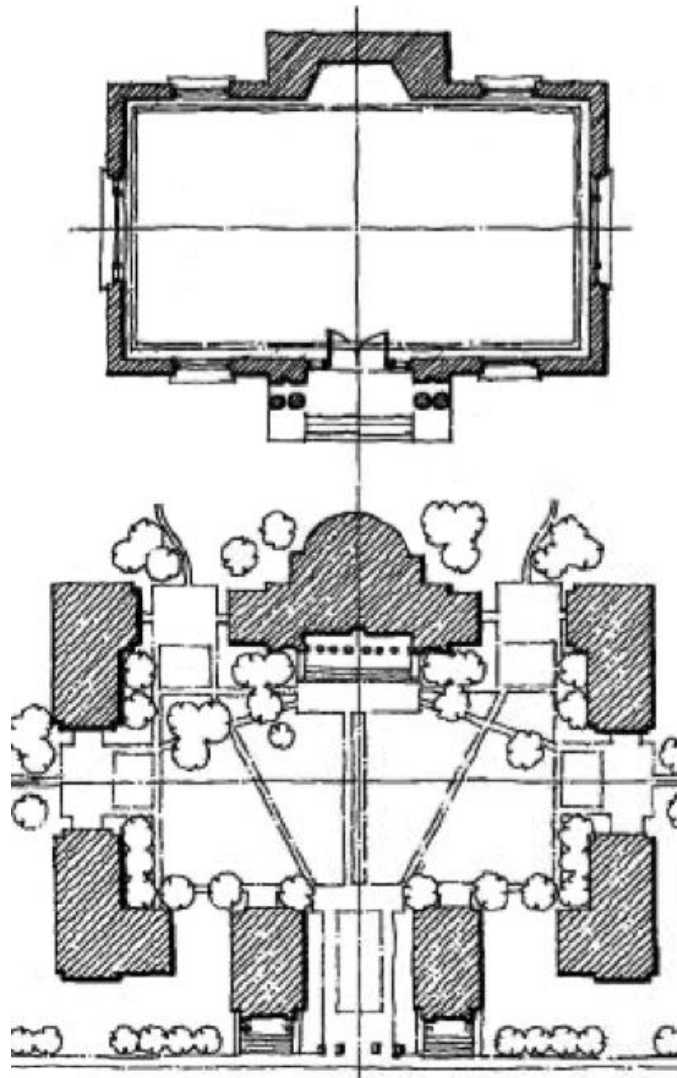

Figure 1



## CAMPUS BUILDING TYPOLOGY THE EDGE-DEFINING TYPE

This building type often performs the role of the common foot soldier, but it may also take on heroic assignments. The generic configuration of the type is that of an elongated rectilinear volume. Most often entry is achieved on the center of one of the long faces, however edge entries, or entry from one of the narrow elevations is also possible (see facade guidelines). This building type commonly aligns its eaves and ridgelines, not the gable end, to the quadrangle thus reinforcing the geometry of this exterior room. A central corridor gives access to the rooms. Typically the corridor is double loaded, however in some instances a single loaded corridor may serve the needs of the program. The length of this building type may vary from 120 feet to 300 feet, while the width of the type is generally in the neighborhood of 45-90 feet. When this type exceeds the 90 foot width dimension natural lighting and ventilation of the interior spaces becomes impossible. Thus, depending upon the actual intended use of buildings of this type, care should be given to the width of the block.

There are a variety of methods for distributing this type in a campus plan (Figure 2).

- Illustrates this building type located as a central element on the long side of a campus quadrangle – the building performs both the role of edge definer and central focus.
- Much the same might be said about the positioning of the type in this configuration, however because the building alone forms the edge of the narrow side of a long quadrangle, it tends to take on a more heroic dimension.
- In this instance the type is paired to form both the wall to the quadrangle as well as a threshold to the campus.
- The final illustration of this type in context is interesting because it presents its end elevation to the major quadrangle of the campus while forming the edge of a new quadrangle behind the first building discussed in this drawing.

Examples of this building type on the UGA campus are Old College and New College, at other institutions, Nassau Hall, Princeton and Old East and Old West at UNC Chapel Hill. The type might accommodate housing, classrooms, laboratories, administrative activities, and a wide variety of other functions. It is typically the most prevalent variety of building to be found on college campuses. This type along with the Centralized Type form the two essential building blocks of campus architecture from which all other types might be derived.



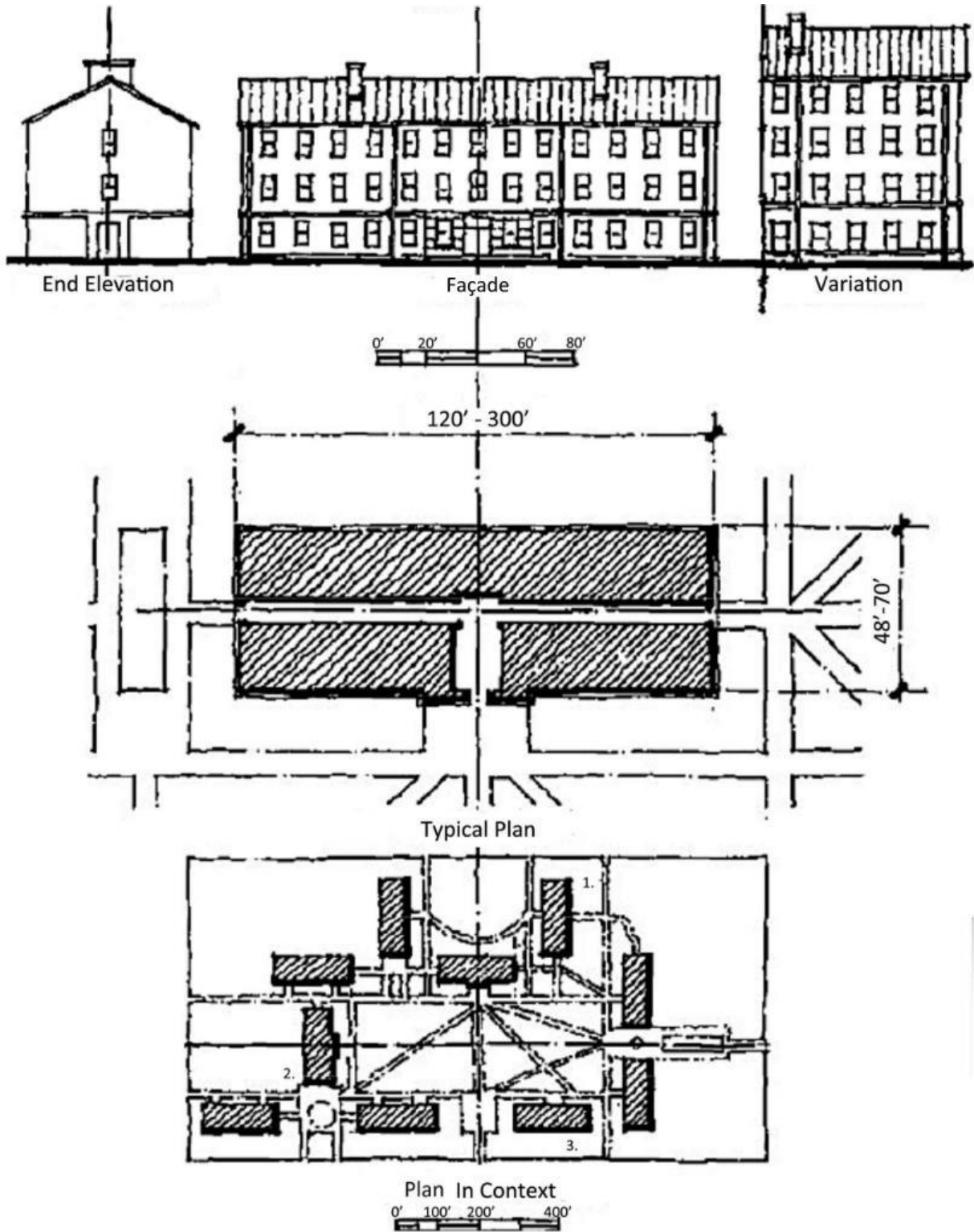

Figure 2



## CAMPUS BUILDING TYPOLOGY THE CENTRALIZED TYPE

This building type is often associated with a heroic posture within a campus plan, however, the type might defer to other buildings depending upon its specific context. The general configuration of the type is that of a compact rectilinear volume, however other platonic forms are also associated with this type circular, octagonal, or other centralized form. Entry is most often achieved on the center of one of the narrow facades and the type most often presents its gabled end to the quadrangle thereby gaining a certain amount of visual attention. Generally, the type houses one large open space internally — often conceived of as a space of assembly. The dimensions of the type vary dramatically and should be determined based upon a mitigation of the concerns of the context against those of the building's function.

There are a variety of methods for distributing this type in a campus plan, refer to Figure 3.

- Illustrates this building in a central position on the long edge of a campus quadrangle (a position analogous to that of a hearth in a room)
- The positioning of a pair of buildings around a principal campus axis forms both edge and threshold to the quadrangle.
- The placement of the type in this position affords four separate exposures – the building is seen in the round (from all sides). This later placement can present problems in servicing the building if the concerns of use are not properly mitigated against those of the campus context. A chapel or assembly hall might be well served by this location, while a dining hall might not work well with the context given an intensive service component of the program.

Examples of this building type on the UGA campus are the Chapel and the Phi Kappa building, at other institutions, the Rotunda at the University of Virginia and Whig and Clio Halls at Princeton. The type might accommodate various assembly activities: chapel, lecture hall, gymnasium, dining hall, etc. When used in conjunction with the Edge Defining Type in a single unified composition an unlimited variety of building forms might be created.

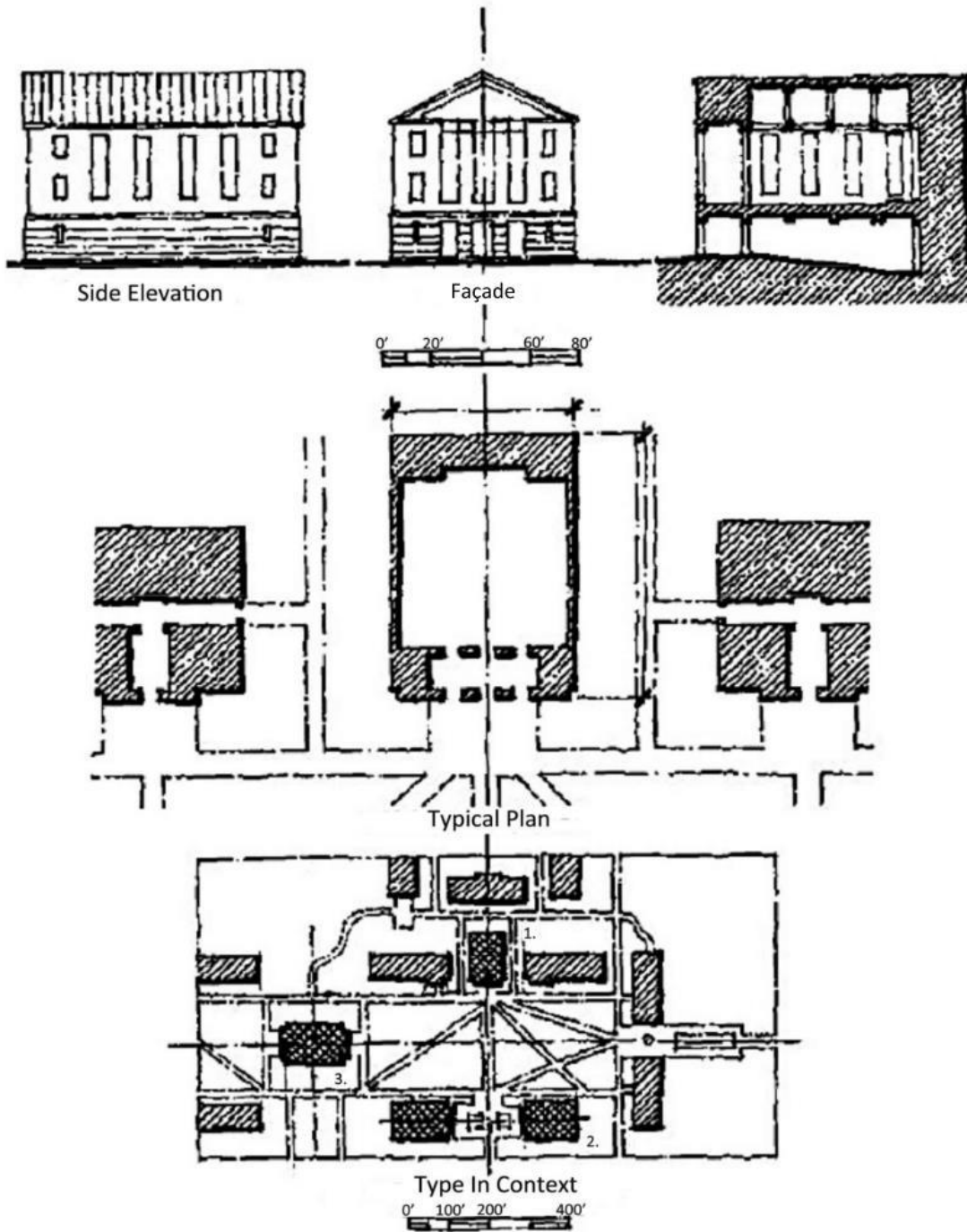

Figure 3



## CAMPUS BUILDING TYPOLOGY THE COMPOSITE TYPE

While many contemporary building programs might not be readily addressed by either the Edge-Defining or the Centralized Types alone, in combination the two building types form the essential characteristics of the Composite Type. It is more difficult to talk about general configurations of this type because the possible combinations and recombination of the basic “building blocks” of typology are limitless. For an insight into the variety of possibilities see, N.C. Curtis, *Architectural Composition*, Cleveland: Jansen, 1927.

The characteristics of how this building type might address a quadrangle are similar to those outlined in both of the previous two types. Again, the actual dimension of the type may vary dramatically, so once again a mitigation of the contingencies of the site against those of building use are highly recommended.

Once again there are a variety of methods for distributing this type in a campus plan, Figure 4.

- Illustrates the simplest form of the type – a Centralized Type has been joined with two flanking Edge-Defining Types to form an articulated wall to the quadrangle. The central element provides accent to the quadrangle while the flanking volumes carry the “wall” of the space along the edge of the quad.
- This illustration of the type is a much more complex combination of the campus building blocks. A central space of assembly is aligned with the axis of the quadrangle and is used in combination with a series of edge-defining volumes. A forecourt is formed between the campus quadrangle and the central volume, while an automobile forecourt is formed by the wings, which extend downward at ninety-degree angles to the long axis of the quadrangle. To the far right, a service court is formed, and to the top, edge-defining types wrap the centralized volume to form an internal courtyard.
- In comparison to the previous example, this configuration of the type is very tame. In fact, the type is created by relocating the edge-defining elements at 90-degree angles to the position occupied in example one — thus, forming a forecourt. The advantage of this type is that large building programs can be accommodated in this configuration without dimensionally abandoning a 70-foot maximum building wing width.

Examples of this building type on the UGA campus are the Fine Arts Building and the Business School, at other institutions — Bancroft and Mahan Halls at the United States Naval Academy, Annapolis. Most complex programs can be accommodated by this typology.



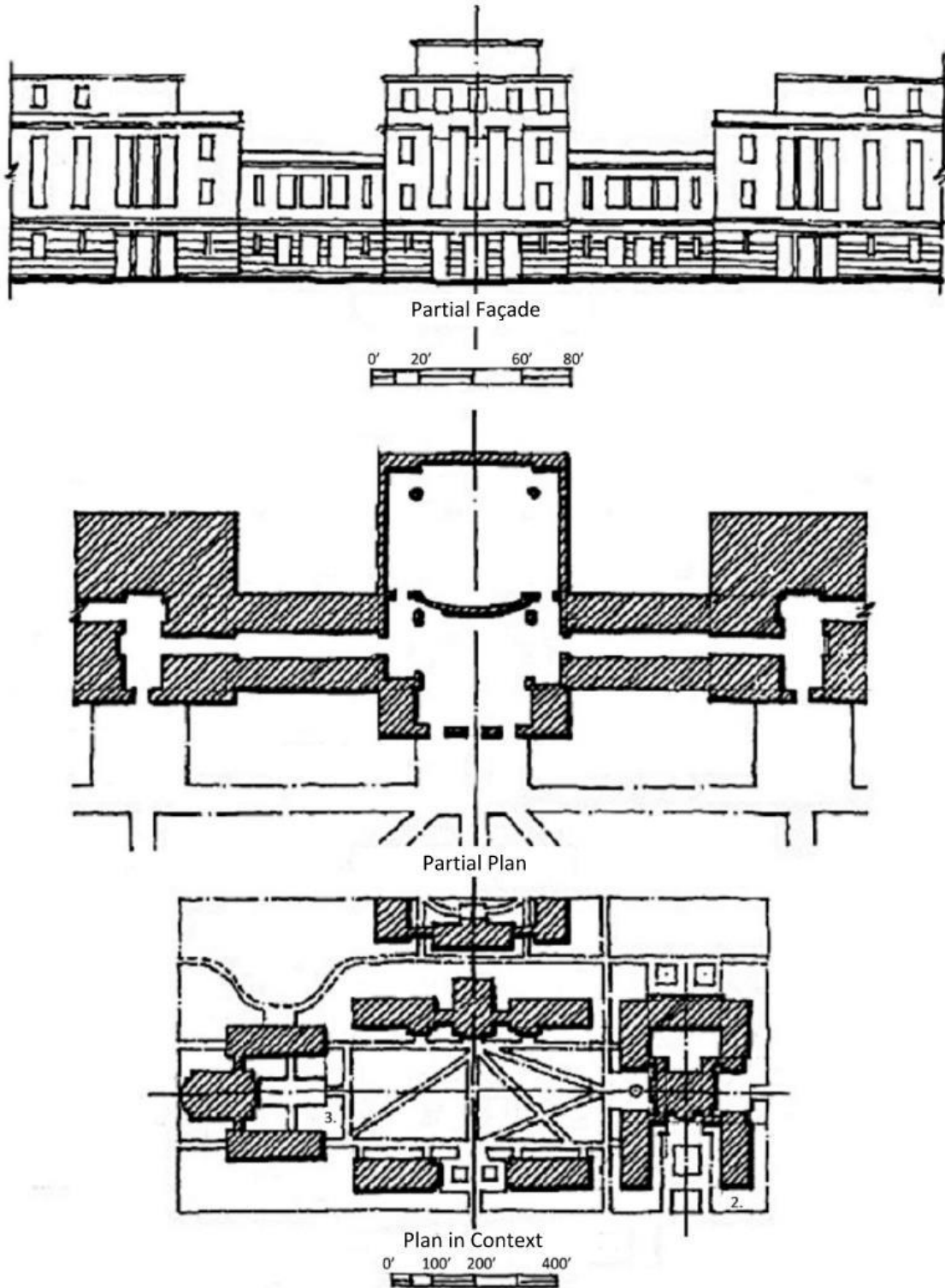

Figure 4





## CAMPUS BUILDING TYPOLOGY THE COMPOUND TYPE

In many cases contemporary programs call for very large footprints to accommodate specialized activities. While the advantage of these large footprints is that many activities can be located in an efficient proximity to one another, the liability is that these types of buildings often become hermetically sealed and connections between interior spaces and the exterior world become severed. Faculty, staff, and students can find themselves living out their entire academic life in these “mega structures” without ever stepping foot outside of their own domain. In short the danger of these “academic malls” are that they often do not contribute in an effective manner to the overall well-being of the university. However, when properly designed these big buildings can indeed contribute well to the life of a campus.

Of primary interest is care given to issues of scale and proportion. Wherever possible, the massiveness of the building should be mitigated by elements in concert with the human scale of the campus environment. The Typical Plan in Figure 5 illustrates an Edge-Defining Type used as a frontispiece, or head house, for a much larger building mass. The site section diagrams located above the typical plan drawing also illustrate two techniques for masking the massiveness of the “large footprint” building. The uphill site illustrates a laboratory building nestled into the grade to minimize the impact of its height and girth, while the downhill site illustrates a parking structure carved into the hillside behind an academic building. The upper deck of this later building is then landscaped and treated as a garden terrace.

Again, there are a variety of methods for distributing this type in a campus plan, Figure 5.

- Illustrates a very large laboratory building, which is flanked by two classroom buildings and headed up by an administrative/office wing, which mediates a connection to the quadrangle.
- Is a center for continuing education, which presents a face both to the outside world (bottom edge) and to the campus quadrangle (right edge). These wings, joined by a rotund element mask the large parking structure located behind. Access to the parking structure is from the extreme right edge of the footprint. It should be noted that care would be given to the surface of the parking structure to create a “handsome” facade in concert with the vocabulary of the campus.
- Illustrates a large student center with large dining halls, meeting rooms, ballrooms, and recreational spaces. The configuration presents a forecourt to the campus quadrangle using two Edge-Defining and one Centralized Type in order to mask the large footprints of the big assembly halls. To the far right a service court provides access for deliveries and waste removal.

Successful examples of this building type are Cabel Hall at the University of Virginia, the Physics and Astronomy Building at Johns Hopkins University, the Student Center at Carnegie Mellon, Barton Hall at Cornell University, and the original buildings on the campus of Duke University.

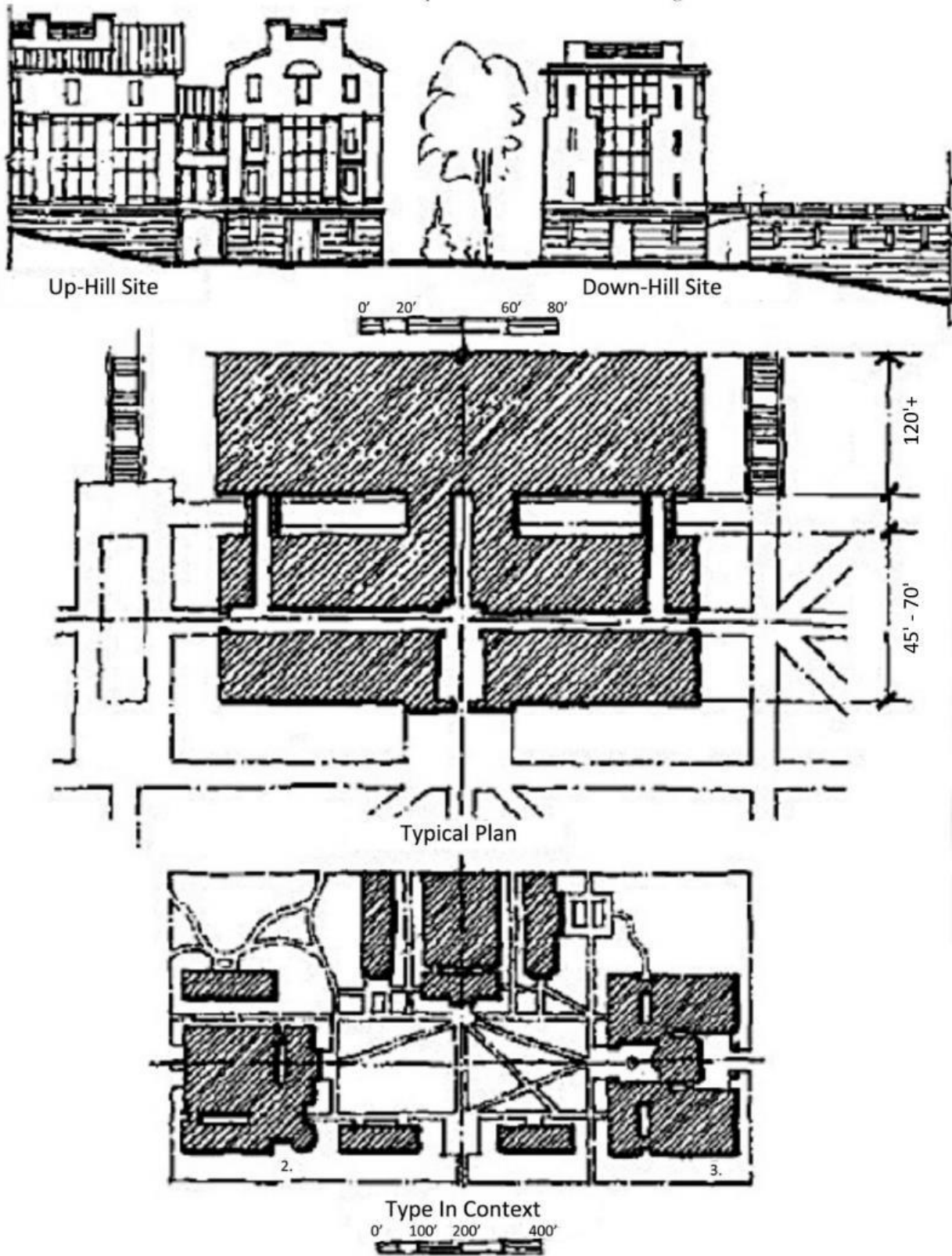

Figure 5



### MASSING DIAGRAMS

These series of diagrams are intended to suggest the limitless rational combinations and recombinations of the "building blocks" to form more complex compositions appropriate to elaborate programs. Each diagram builds upon the previous drawing suggesting a process of elaboration and combination. Note that the massing is not dependent upon a singular response to issues of symmetry/asymmetry, center/edge, base condition, or roof. Both designers and members of the campus community are encouraged to imagine their own formal inventions as an extension of this exercise.

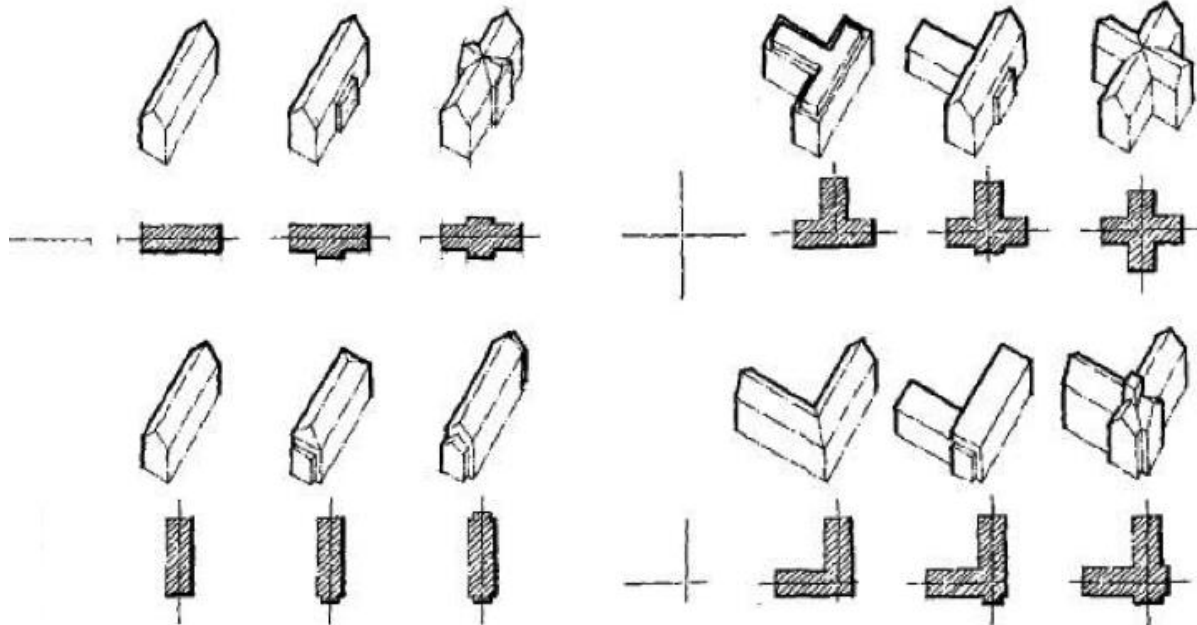

Figure 6

Figure 7

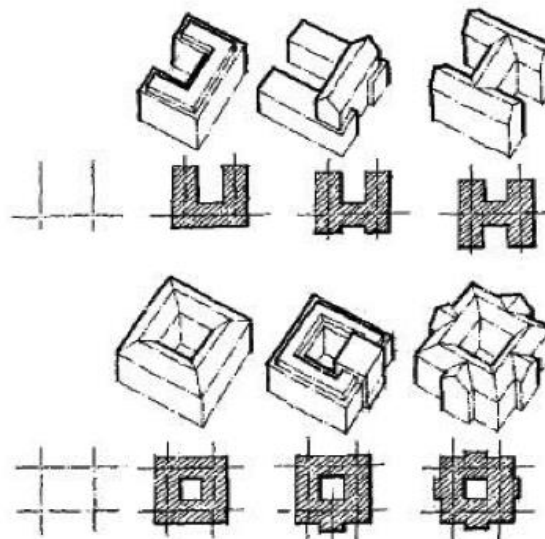

Figure 8



## CAMPUS FAÇADE TYPOLOGY INTRODUCTION

Each of the facade variations illustrated herein derives from the previously mentioned observation, documentation, and analysis of the UGA campus. The proportions of openings and wall surfaces are derived from UGA traditions and may not be directly applicable to other campuses, however, many of the techniques for creating hierarchical “readings” of the facades are generic in nature.

Typically, this study recognizes two generic architectural conditions — that of the wall and that of the frame. Both types are to be found alone and in combination on the UGA campus. Once again, the observations made herein are not an attempt to advocate specific styles, however, it is explicitly the intention of this portion of the document to encourage the development of rationale for the vertical surfaces. Thomas L. Schumacher’s, “Scull and the Mask,” as well as, “The Palladio Variations,” (Cornell Journal of Architecture, New York: Rizzoli) are excellent starting points for discussion of facade making themes. Since a building on a college campus is likely to be kept in service for in excess of 100 years, it is important to give the design of facades considerable attention.



## CAMPUS FAÇADE TYPOLOGY THE PLANAR FAÇADE WITH SIMPLE OPENINGS

This type is derived in part from New College. The aesthetic derives from bearing wall construction techniques. The façade type is characterized by a series of regularly spaced windows of equal dimension. Not only do the windows act as “figure” in the composition of the façade, but the spaces between are also imbued with figural properties. That is, the windows are as interesting to the eye as the wall.

Windows read as discrete architectural elements positioned within the fabric of the wall. The head of the window is characterized by a lintel or flat arch, which occasionally serves as a location for ornamentation. The sills of the window are often stone and project from the surface of the wall. Following the logic of bearing wall construction, the general proportion of each window is that of a vertical rectangle, in this case a square root of two or golden section rectangle. The windows are typically double hung and subdivided into smaller panes.

In this façade type, the ground floor of the building is given special prominence by rustication or by belt coursing. This treatment permits the composition of the wall to relate well to the ground plane. Typical of many buildings on UGA’s campus, the building is capped by a gabled metal roof that is selectively articulated with masonry elements (chimneys, cupolas, etc.). There are examples of very successful buildings on the UGA campus in which the roof is not expressed. Typically, however, these buildings (such as Peabody Hall) terminate the wall with a cornice, or other element, which forms a distinct profile against the sky.



Figure 9





### Planar Façade Variations

- In this series all of the openings in the façade are created through the use of equally spaced windows of identical dimension. Hierarchy is achieved by manipulating the reading of the wall surface and by adjusting the relationship between the opening and the wall.

#### Variation A

- This façade uses a “surround” treatment to distinguish the windows on the first floor from those on the ground and upper floor levels. This treatment may be useful in breaking up the monotony of a façade composed of regularly spaced windows. Additionally, the treatment gives distinction to the first story above the ground level as a place of prominence within the building.

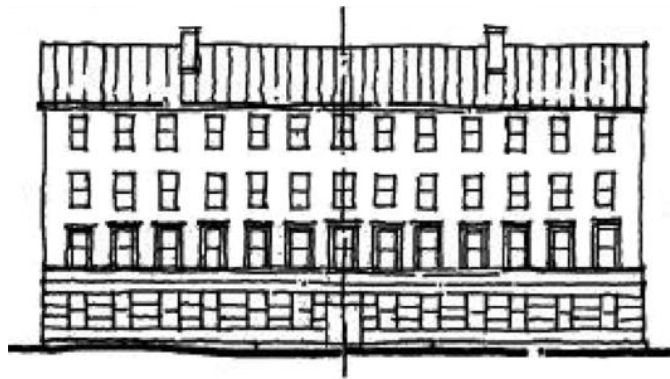

Variation A

#### Variation B

- This façade uses belt courses and rustication to produce a horizontal effect. This treatment may be an appropriate strategy for making tall facades to appear more in scale with a lower context. Additionally, the treatment may be appropriate when the building is intended at a “background” element in a composition wherein the intention is not to have the eye come to rest on this particular building.

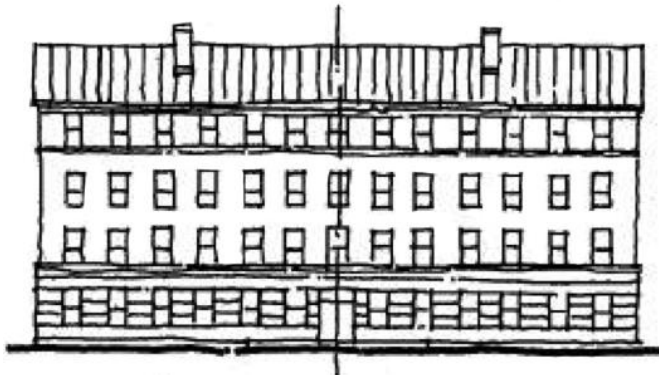

Variation B



#### Variation C

- This façade develops a strong reading of “center” by creating an intersecting gable at the midpoint of the composition. Addition of an attic element and the positioning of chimneys create a strong sense of center. This may be an appropriate treatment when the building is an important element of a group plan, such as the main building of a college, or a prominent building on an open space or quadrangle.

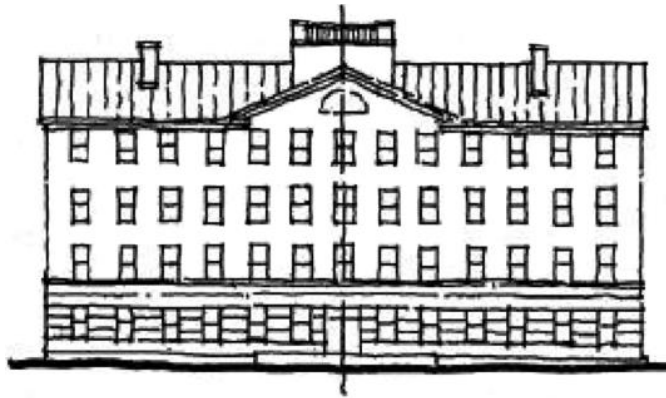

Variation C

#### Variation D

- This façade is characterized by a development of localized centers at the extremities of the façade. The result is a dual centered façade. The use of a segmental gable that penetrates the eaves line of the roof, strategically positioned chimneys, and downspout, create an emphasis upon the edges of the overall composition. This treatment may be used in conjunction with elements of Variation C to create a hybrid that emphasizes both center and edge simultaneously. The type may be most appropriate for buildings with multiple entries, for buildings that attempt to downplay their hierarchical importance on a quadrangle or open space, or for buildings, which contain more than one academic department.

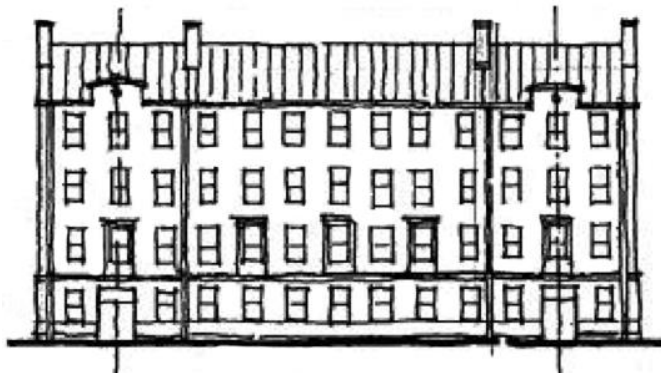

Variation D



## CAMPUS FAÇADE TYPOLOGY THE PLANAR FAÇADE IN RELIEF

This type is very similar to the previous example; however, it differs in that the surface is developed in terms of relief or depth of the wall surface. The amount of relief may vary from only a few inches to that of many feet (in the case of a freestanding portico). Through the introduction of relief, a hierarchical reading of the openings (windows and doors) can be developed.

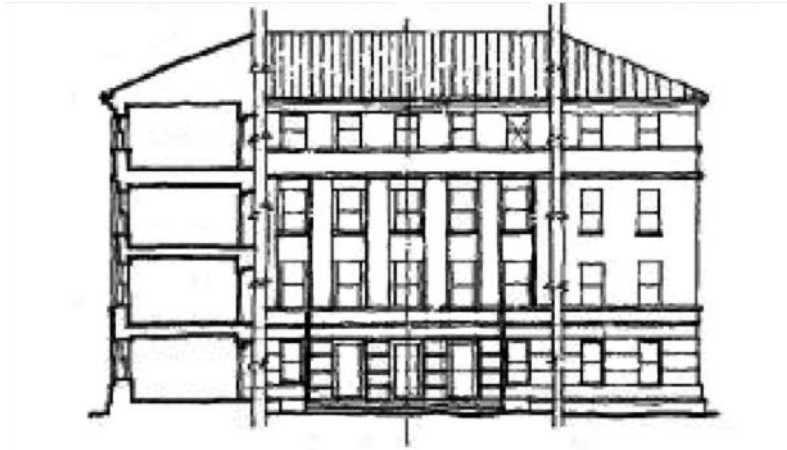

Figure 11

### Planar Facade in Relief Variations

- In this series all of the openings in the facade are created through a use of equally spaced windows of identical dimension. Hierarchy is achieved by manipulating the degree of surface relief either in front of or behind the dominant wall plane.

### Variation A

- This facade uses a modestly scaled series of pilasters in front of the dominant wall surface to create a centralized reading and emphasis upon the entry. An element breaking the roof line (perhaps an elevator core) further emphasizes the centrality of the composition.

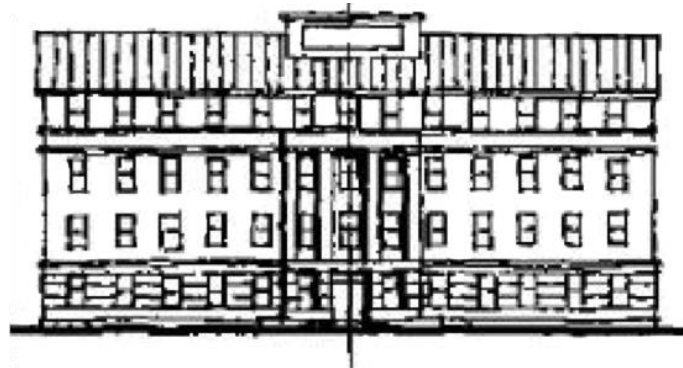

Variation A



#### Variation B

- This facade creates a large centralized element by “excavating” or carving into the dominant wall plane in order to create a series of vertical openings articulated as pilasters. The vertical scale of this gesture suggests a more monumental and perhaps heroic character than Variation A.

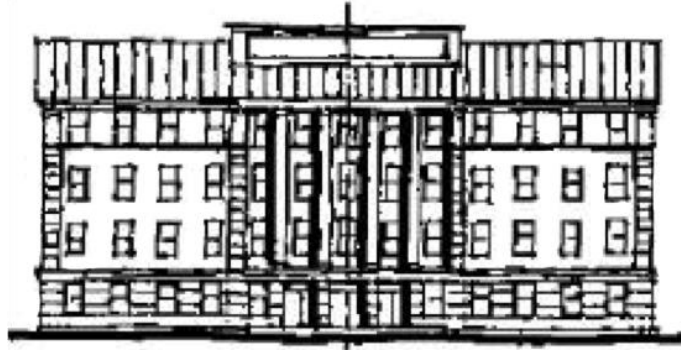

Variation B

#### Variation C

- This facade balances emphasis to both center and edge by once again “excavating” the dominant wall plane in order to create a rhythm of pilasters. The cadence of vertical openings is terminated at the left and right of the facade by a reassertion of the dominant plane and the creation of secondary entrances on the ground floor within these zones.

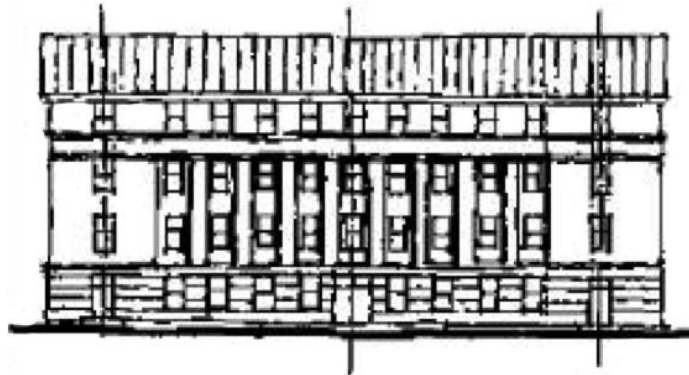

Variation C



#### Variation D

- This facade uses modestly scaled elements applied to the dominant plane of the facade in order to create emphasis at the edges of the composition (in this case the center is down played). By covering half of this diagram, one can imagine an asymmetrical application of this technique.

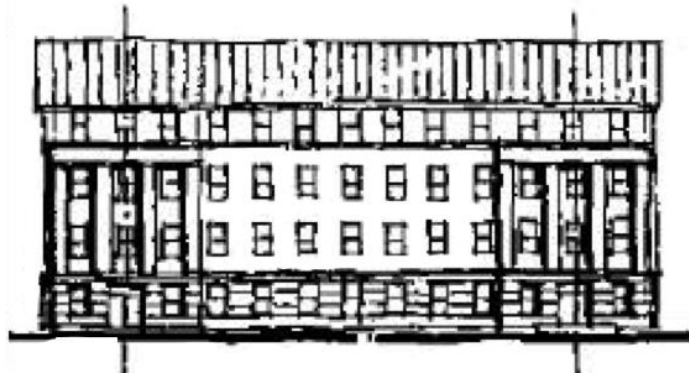

Variation D





### CAMPUS FAÇADE TYPOLOGY THE PLANAR FACADE WITH CLUSTERED OPENINGS

This type is likened to the first example in that there is little relief in the surface of the facade. It achieves its goals in establishing hierarchy by clustering openings of identical proportion and dimension. The type suggests a hybrid of frame and wall characteristics.



Figure 13



#### Planar Facade with Clustered Openings Variations

- In this series all of the openings in the facade are created through a use of windows of identical dimension. Hierarchy is achieved by manipulating the spacing of windows and other openings.

##### Variation A

- This facade develops a hierarchical reading by means of creating a cluster of windows at the center of the composition. The end bays of the composition terminate the composition by paring windows in order to create figural emphasis.

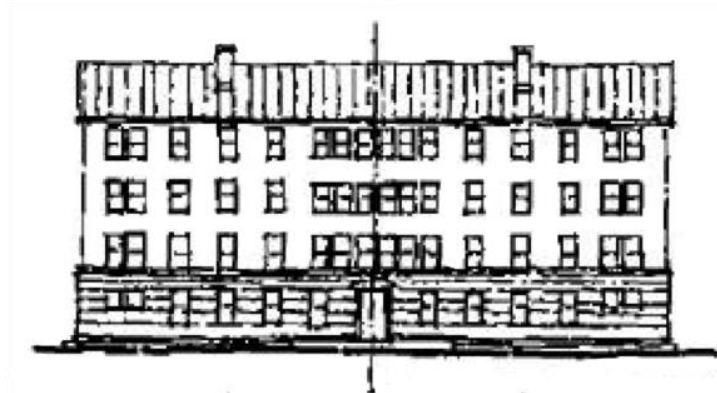

Variation A

##### Variation B

- This facade develops a duality of reading — it emphasizes center through placement of the door and the symmetry around the center, but it creates a tension between center and edge because the large groupings of windows left and right compete for the eye's attention.

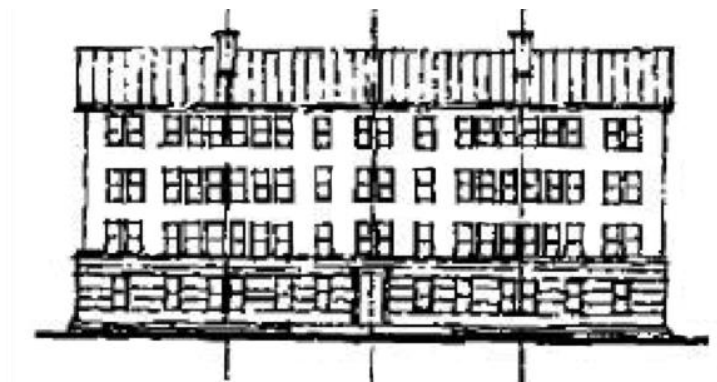

Variation B



#### Variation C

- This facade utilizes a more articulated symmetry to create a bipartite composition. The actual center of the facade is distinctly down played in favor of development of the dual figure groupings around a vertical axis. Dual doors on the ground level reinforce the notion of a two-part composition.

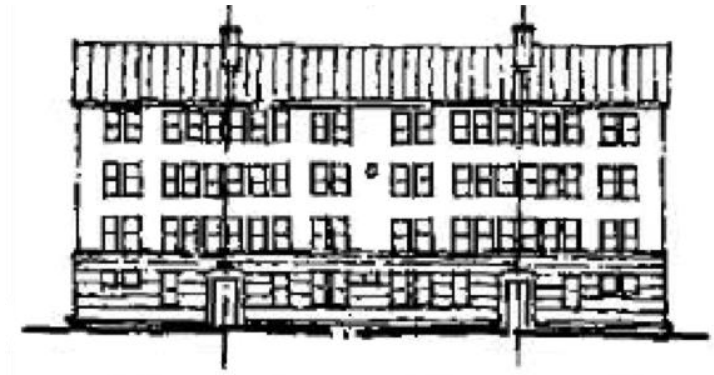

Variation C

#### Variation D

- This facade emphasizes the edge elements through tiers of paired windows located in the end bays. The emphasis upon edge is further advanced by the position of the doors on the ground floor.

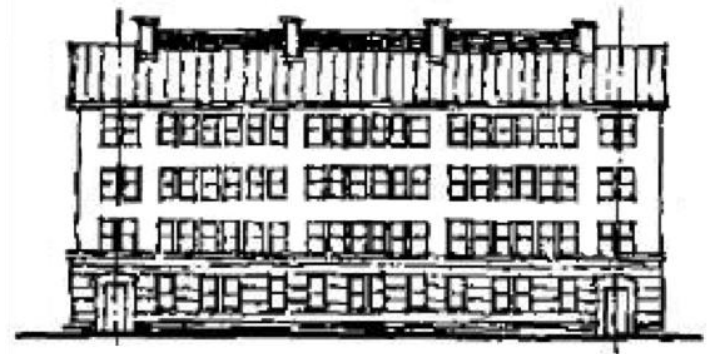

Variation D



### CAMPUS FAÇADE TYPOLOGY THE FRAME FAÇADE IN RELIEF

This final example is similar to the previous example in that it employs clustering of openings, however it also utilizes modest relief in order to establish hierarchical readings.

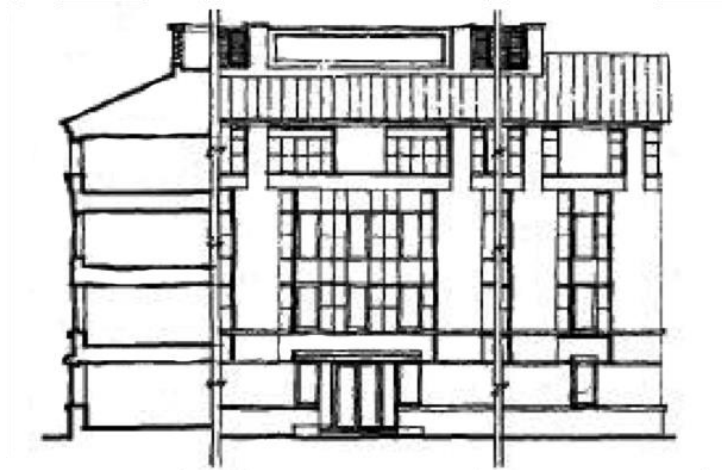

Figure 15



#### Frame Facade in Relief Variations

- Hierarchy is developed by the manner in which the window or opening is surrounded and the degrees to which elements such as spandrels are expressed as materially separate from the actual window openings.

#### Variation A

- This facade develops a distinct reading of centrality by contrasting the scale of the figure grouping on center with those repetitive bays located to the left and the right of center. The door element is placed on center to further emphasize this portion of the composition.

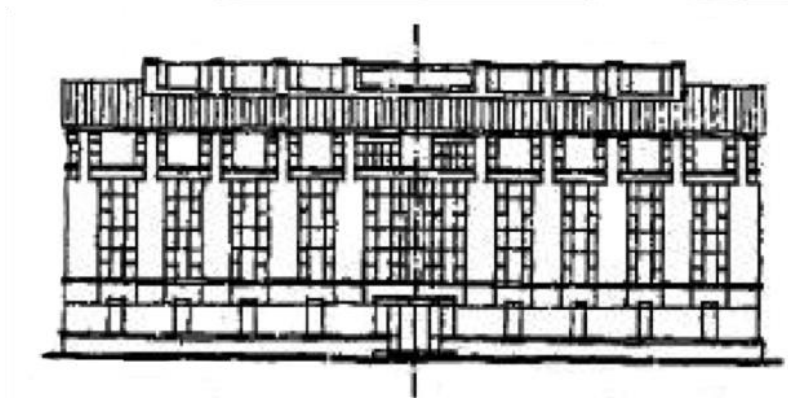

Variation A

#### Variation B

- This facade emphasizes the edge by employing large-scale figure groupings to the extreme right and left of the composition. As in the previous example, doors are associated with the large-scale figures in order to underscore the compositional strategy.

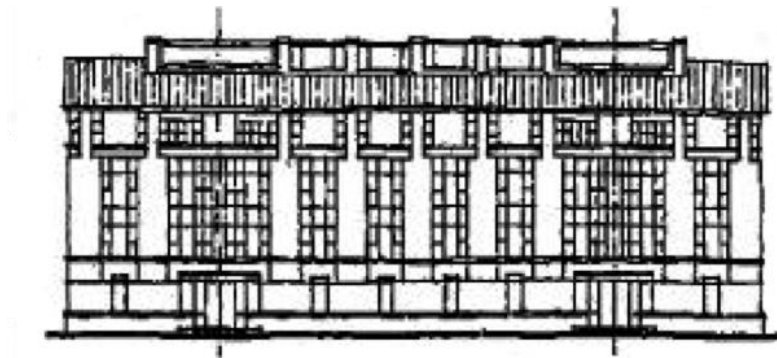

Variation B





#### Variation C

- This facade is almost the same as Variation B, however the emphasis upon edge has been played down by utilizing large-scale figure groupings in the central range of the facade. The emphatic statement of edge seen in Variation B gives way to a more subtle suggestion of edge in Variation C.

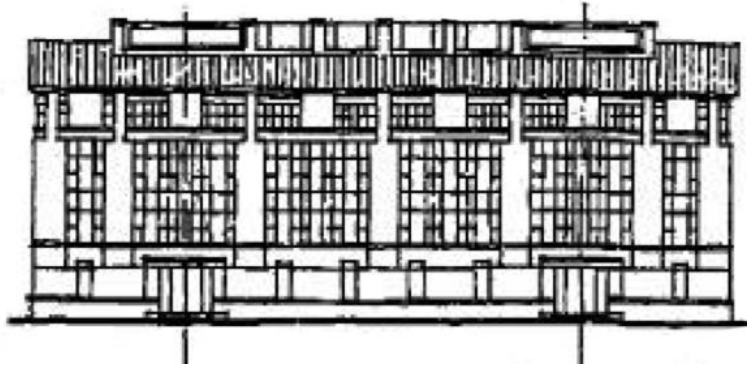

Variation C

#### Variation D

- This facade uses the smaller bays which were prevalent in Variation A in order to create edge emphasis. The end bays containing the doors feature spandrels which are distinguished from the material of the windows, thus presenting a greater degree of solidity and emphasis upon termination of the facade rhythm.

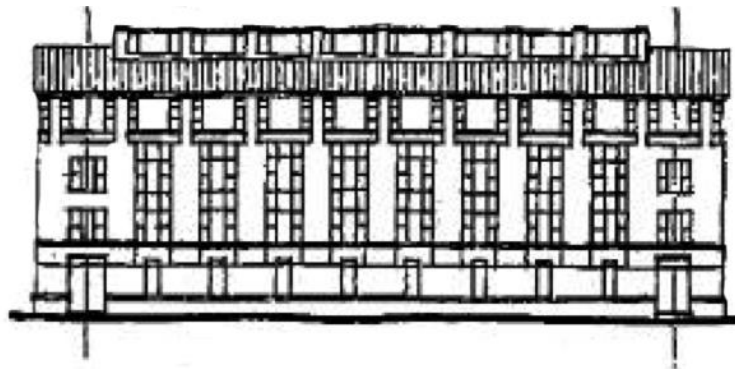

Variation D



## CONCLUSION

Architects commissioned for UGA buildings should not underestimate the challenge of designing within the shadow of the architects of UGA's early campus buildings. To understand how to integrate a new project into the fabric of UGA's campus, one needs to read thoroughly the overview of UGA's history that summarizes the founding fathers' intentions for the University.

- Stewardship of the land
- Balance of buildings and open space
- Consistent architectural language

The buildings of North Campus relate to one another along connecting axes. Buildings were aligned along open spaces forming an architectural edge enclosing exterior space and creating outdoor rooms. Walks and roads were generally laid out on axes, tying the campus together.

Essential to UGA's growth is the infilling of future buildings within the existing campus such that clear, memorable open spaces are formed. In this regard, site selection is vital to the success of each new building, and the success of the campus as a whole.

Even more important is the successful integration of new buildings with the broad surrounding context. By definition, a campus is a collection of interrelated buildings and supporting facilities arranged in and around open space. The challenge, then, is for every UGA architect to think globally (campus wide) and to act locally (site specific).

Therefore, in initiating the design process for any building or open space on UGA's campus, each design team should begin with a comprehensive look at the campus context and history. This first step should include an analysis of the site: its history, pedestrian and vehicular traffic, infrastructure, service, views and vistas, topography, vegetation, massing, and architectural character. In synthesizing this analysis, a primary goal of all building projects within UGA's campus should be to create clear, simple open spaces and quadrangles that connect to other existing or proposed adjacent spaces. In this regard, buildings should be budgeted to extend their site work as far as is reasonably possible. At the schematic design phase, site plans should show the ground floor plan of the building within the overall campus context and adjacent open space.

These guidelines do not advocate the replication of the original campus buildings in the design of new buildings. Rather, they suggest the continuing evolution of the principles used in those original campus buildings. Using similar scale, proportions, form, materials, and hierarchy one can design in harmony with the existing grounds and buildings.

The design for both grounds and buildings should then refer to these guidelines in the spirit of both recollection and invention. Examples of this attitude can be seen at other campuses, acting as relevant paradigms for UGA's architects and planners. Some of these examples include the images pictured at right

In summary, the sustained implementation of UGA's Campus Plan relies on reestablishing many of the principles that Charles Leavitt and the pre-WW II architects established on UGA's campus. Leavitt established in his 1906 physical master plan a balance of building and open space, and a stewardship of



the land. Pre-WW II buildings on campus express a consistent, yet inventive architectural language. In this regard, UGA's grounds and buildings should be like a good academic curriculum combining tradition and innovation.



Founders Memorial Garden



University of Georgia's North Campus

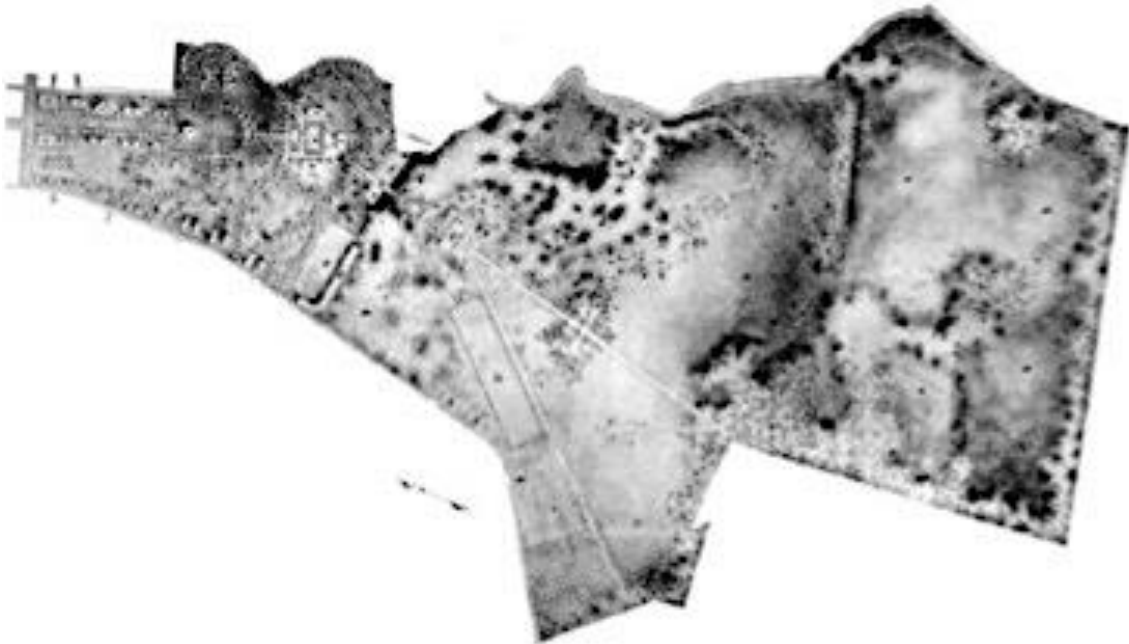

Physical Master Plan by Charles Leavitt (1906)



Harvard Law School  
Kallman McKinnel  
Wood



Princeton University  
Koetter Kim



Syracuse University  
Bohlin Cywinski  
Jackson



Johns Hopkins  
University  
Ayers/Saint/Gross



Carnegie Mellon  
Michael Dennis &  
Associates



Stanford University  
Antoine Predock



Princeton University  
Todd Williams &  
Billie Trien



University of Virginia  
Ellenzweig &  
Associates