



26 00 00
GENERAL ELECTRICAL REQUIREMENTS

1. GENERAL

A. Related sections:

- i. 00 00 07 – Design Professional Design Process Requirements
- ii. 00 00 08 – Design Professional Documentation Requirements & Deliverables
- iii. 00 00 13 – Designing Learning Environments
- iv. 01 41 26.06 – Dining Services
- v. 01 81 00 – Facility Performance Requirements
- vi. 01 91 13 – General Commissioning Requirements
- vii. 23 05 14 – Variable Frequency Drives
- viii. 23 09 23 – BAS
- ix. 26 05 19 – Low-Voltage Electrical Power Conductors and Cables
- x. 26 05 26 – Grounding & Bonding for Electrical Systems
- xi. 26 05 33.13 – Conduit for Electrical Systems
- xii. 26 05 43 – Underground Ducts and Raceways for Electrical Systems
- xiii. 26 09 23 – Lighting Control Devices
- xiv. 26 09 36 – Modular Dimming Controls
- xv. 26 09 43.16 – Addressable Fixture Lighting Control
- xvi. 26 22 00 – Low-Voltage Transformers
- xvii. 26 24 13 – Low-Voltage Switchgears/Switchboards
- xxviii. 26 24 16 – Low-Voltage Panelboards
- xix. 26 24 19 – Motor-Control Centers
- xx. 26 32 00 – Packaged Generator Assemblies
- xxi. 26 41 00 – Facility Lightning Protection
- xxii. 26 51 00 – Interior Lighting
- xxiii. 26 56 00 – Exterior Lighting
- xxiv. 26 56 13 – Lighting Poles and Standards
- xxv. 26 56 16 – Parking Lighting
- xxvi. 26 56 19 – Roadway Lighting
- xxvii. 26 56 29 – Site and Building Entry Lighting
- xxviii. 26 56 33 – Walkway Lighting
- xxix. 26 56 36 – Flood Lighting
- xxx. 27 00 00 – General Communications Requirements
- xxxi. 33 71 18 – Electrical Underground Ducts & Manholes
- xxxii. Appendix A

- B. The Design Professional is recommended to refer to Sections 00 00 07 Design Professional Design Process Requirements, 00 00 08 Design Professional Documentation Requirements and Deliverables, and 01 81 00 Facility Performance Requirements before beginning design. DP shall also coordinate location and size of electrical rooms for cost effective and safe electrical power distribution.
- C. Electrical Design Consultant shall locate the IT drops for BAS and Mechanical Equipment on the electrical drawings.

*Revised July
30, 2024*



- D. Electrical Design consultant shall coordinate with the Mechanical Design consultant to ensure that hydronic, domestic, condensate, waste, etc. piping shall not be routed above electrical equipment (transformers, panels, switchgear, etc.).
- E. Designing for Learning Environments
 - i. In flat classrooms with movable furniture, regularly spaced wall-mounted electrical outlets should be provided at 18 inches above finished floor (AFF) spaced maximum 12 feet horizontally. In classrooms with fixed tables, duplex electrical receptacles will be provided every other seat on the work surface. Ensure that adequate convenience receptacles are provided on or near the instructor station.
 - ii. Avoid power poles or other features that block views of instructors, markerboards, and screens. Additionally, floor receptacle covers shall be rated for pedestrian traffic and shall be mounted flush with the floor surface.
- F. Power Distribution Design
 - i. **For UGA Athens Main Campus Only:** The power for campus originates at the main campus sub-station on UGA's east campus. All medium voltage work on campus is performed by FMD. The Project Manager will provide guidance as to whether the cost of any required medium voltage work will be included in the Cost of the Work, the Bid, or if it will be a direct project cost. The Design Professional will coordinate with the Project Manager and FMD to verify which scope of Work that will be provided by FMD and which Work will be provided by the Contractor. Typically building service transformers and loop feed switches will be provided by FMD and installed by FMD. In some cases, FMD will supply and install 15 kV cables and associated splice kits and termination kits, and 2-hole compression lugs for transformer primary spaces (coordinate with Project Manager and FMD based upon project requirements and conditions). On new building projects, the Design Professional will include concrete duct banks and manholes for medium voltage primary to the utility transformer or loop feed switch and the associated pads for the utility equipment in their design documents.
 - ii. The power for UGA Athens Health Sciences Campus and Board of Regents properties along South Milledge, Athens, Georgia is provided by Georgia Power.
 - iii. Empty concrete duct banks, concrete pads, etc., related to the medium voltage Work will be by the Contractor, and FMD will set the building service transformers and install the associated medium voltage cabling for the primary. The Contractor shall provide and install all secondary service cable in concrete duct banks (to be included in Design Professionals' design documents), using double-compression lugs, and make the final secondary connections to the utility transformer.
 - iv. Electrical One-line diagram(s) showing incoming service(s), emergency generator(s), automatic transfer switches, switchgear/switchboard ratings, breaker sizes and feeder sizes shall be furnished for each facility. All downstream equipment ratings such as motor control centers (MCC's) and panelboards, etc., shall be indicated. Existing one line diagram(s) shall be updated for all renovation projects. Partial one line diagrams are not



acceptable. When existing one-line diagrams are not available, an as-built one-line diagram shall be created based on the Design Professional's field survey. All one-line diagrams shall include short-circuit ratings at all nodes in the system, as well as arc-fault ratings. Electrical services (including utility transformer) shall be sized according to the demand load. The Design Professional shall apply industry standard demand factors in conjunction with NEC requirements in their calculations for the sizing of all electrical services including all electrical distribution equipment (distribution transformers, switchgears/switchboards, panelboards, etc.).

- v. Power riser diagrams for multistory facilities shall be furnished in addition to one-line diagrams.
- vi. Circuit breaker long-time and short-time trip settings shall be furnished as part of the engineering design. Settings shall be based on the circuit breaker coordination study which is an integral part of the engineering scope.
- vii. Power and lighting plans shall indicate all electrical apparatus including switchgears, switchboards, wall receptacles, panelboards, emergency generators, uninterruptable power supplies (UPS's), MCC's and HVAC equipment, light fixtures, etc., and all the associated wiring and conduits. The Design Professional shall calculate voltage drop on all circuits per NEC recommendations and size each individual circuit's conductors accordingly. Notes instructing the Contractor to up-size circuit wiring over a certain distance will not be accepted.
- viii. Detailed schedules showing connected loads for each circuit shall be furnished for each panelboard. The schedules shall contain connected and demand kVA, type of load, location of load including room number and electrical characteristics such as number of poles and ampere rating for each circuit. Total connected load for each phase shall be furnished for each panel, as well as demand load. Panelboard schedules shall also contain mains ratings (225A/14 kAIC, 800A/42 kAIC, etc.) whether the panel is main breaker or main-lug only, operating voltage(s) (208Y/120V, 480Y/277V, etc.), number of phases (1 or 3 Phase), number of wires (3W or 4W), and general notes related to service entrance rating (if applicable), NEMA enclosure rating (1, 3R, 4X, etc.), top or bottom feed, and mounting type (flush, surface, etc.). For all switchgears, switchboards, or panelboards, all loading between phases shall be designed to be balanced at maximum +/- 10% between any 2 phases.
- ix. Electrical load tabulation and calculations shall be provided to the UGA Project Manager. The Project Manager will coordinate with FMD to confirm acceptance of the Design Professional's design for the building service transformer capacity, associated pad, opening, and manhole sizes and locations, underground vault locations and size, and routing of all medium voltage concrete duct banks. Load tabulation shall include types of load such as lighting, heating, chillers, air handlers, pumps, elevators, general purpose outlets, dedicated outlets for dedicated equipment, etc. A diversity factor for each type of load shall also be included. This task also serves as the basis to determine switchgear capacity.



- x. All existing equipment (switchboards, panelboards, motors, circuit breakers, transformers, disconnect switches, conduit/wiring, etc.) that are associated with the project shall be verified and assessments shall be made if modifications and/or upgrades are required. All existing panelboards associated with the project shall be surveyed and recorded by the Design Professional.
- xi. Design Professionals shall furnish design associated with secondary feeders, duct banks, and the routing to the incoming service switchgears. Design Professionals shall instruct Contractors to furnish and install all medium voltage concrete duct banks with either 6-inch or 5-inch diameter conduits each with two (2) 200 lb. test nylon pull strings, manholes, vaults and transformer pads as required.
- xii. Building service transformers and their primary and secondary duct banks, outdoor switches, etc., shall be located on the electrical site plan, as well as the routing of all concrete duct banks (both medium voltage primary & low voltage secondary).
- xiii. Electrical equipment, disconnects, conduits etc., shall be independently supported per the NEC, and not secured to mechanical equipment and ductwork.
- xiv. Transformer CT Sizing Table provided for general reference below:

12.47Y/7.2kV-480Y/277V LIQUID-FILLED, PAD-MOUNT TRANSFORMERS					
kVA	FLA	125% FLA	O.C. DEVICE	PREFERRED CT TURNS RATIO	ALTERNATE CT TURNS RATIO
150	180.4	225.5	225A/200A	250 TO 5	200 TO 5
225	270.6	338.3	350A/300A	400 TO 5	300 TO 5
300	360.8	451.1	450A/400A	500 TO 5	400 TO 5
500	601.4	751.8	800A/600A	800 TO 5	600 TO 5
750	902.1	1,127.6	1200A/1000A	1200 TO 5	1000 TO 5
1000	1,202.8	1,503.5	1600A	1600 TO 5	NONE
1500	1,804.2	2,255.3	2500A/2000A	2500 TO 5	2000 TO 5
2000	2,405.6	3,007.0	3000A	3000 TO 5	NONE
2500	3,007.0	3,758.8	4000A	4000 TO 5	NONE
3000	3,608.4	4,510.5	4000A	4000 TO 5	NONE

12.47Y/7.2kV-208Y/120V LIQUID-FILLED, PAD-MOUNT TRANSFORMERS					
kVA	FLA	125% FLA	Sec. O.C. Device	PREFERRED CT TURNS RATIO	ALTERNATE CT TURNS RATIO
150	416.4	520.4	600A/500A	600 TO 5	500 TO 5
225	624.5	780.7	800A	800 TO 5	NONE
300	832.7	1,040.9	1000A/1200A	1000 TO 5	1200 TO 5
500	1,387.9	1,734.8	2000A/1600A	2000 TO 5	1600 TO 5
750	2,081.8	2,602.2	3000A/2500A	3000 TO 5	2500 TO 5



1000	2,775.7	3,469.7	4000A/4000A	4000 TO 5	3500 TO 5
------	---------	---------	-------------	-----------	-----------

- xv. Prior to completion of Schematic Design, the Design Professional shall confirm with UGA Project Manager if the Contractor shall hire 3rd party NETA certified testing agency to perform ANSI/NETA ECS in conjunction with ANSI/NETA MTS for renovations.
- xvi. For all switchgears, switchboards, or panelboards, all loading between phases shall be designed to be balanced at max. +/- 10% between any two surfaces.
- G. Lighting plans shall be furnished to show all lighting fixture layouts including emergency lights with circuits, switches, wire and conduit sizes indicated. Lighting plans showing only lighting fixture layout are not acceptable. Lighting panelboard schedules and lighting fixture schedules shall be furnished. The Lighting Fixture Schedule shall include for each fixture: fixture designation (A, B, A1, B1, X1, X2, OA, OB, etc.); fixture description; manufacturer(s); complete manufacturer(s) part number(s); lamp type; / number of lamps (if not LED); lumen output for LED lighting fixtures; operating voltage; operating wattage or volt-amps; mounting type; mounting height; specific remarks or notes for individual fixtures (if required). If all lighting fixtures associated with a project are 4000K LED, a general note within the Lighting Fixture Schedule will suffice for the lamp type and color temperature columns.
- H. Prior to installation of electrical appurtenances, contractor shall coordinate a meeting at the project site involving the electrical subcontractor, Design Professional, UGA Project Manager, and OUA Interiors to review the furniture layout plan(s) and coordinate electrical appurtenance locations with the plan prior to installation of outlets, switches, etc. that may conflict with the furniture layout.
- I. Electrical equipment identification tags shall comply with requirements shown in UGA Standard Details (See Appendix A).

*Revised July
30, 2024*



26 05 13
MEDIUM VOLTAGE CABLE

1. GENERAL

- A. Related sections:
 - i. 26 00 00 – General Electrical Requirements
 - ii. 33 00 00 – General Utilities Requirements
- B. Design Professional shall specify Okonite “Okoguard URO-J” jacketed 15 kV medium voltage cable with aluminum conductor with copper concentric neutral in #4/0 AWG with full neutral or 500 MCM (kCMIL) with 1/3 neutral sizes or approved equal.

2. PRODUCTS

- A. UGA only uses Okonite “Okoguard URO-J” 15 kV jacketed medium voltage cable with aluminum conductor and copper concentric neutral.
 - i. Central conductor – Aluminum per ASTM B-609, Class B stranded per B-231.
 - ii. Filled strand – Water swellable powder compliant with ICEA T-31-610 water penetration resistance and ANSI/NEMA Class A connectorability requirements.
 - iii. Conductor and insulation screens – Extruded semi-conducting ethylene-propylene rubber meeting or exceeding ICEA S-94-649.
 - iv. Insulation – Meets or exceeds ICEA S-94-649 with 133% insulation level.
 - v. Concentric conductor (neutral) – Bare, uncoated, soft drawn copper.

See section 33 71 19 for Primary Concrete-Encased Ducts Detail and other details.



26 05 14

MEDIUM VOLTAGE CABLE INSTALLATION – OUTSIDE CONTRACTOR

1. GENERAL

A. References

- i. The publications listed below form a part of this section to the extent referenced:
 - a. American Society for Testing and Materials (ASTM)
 - b. ASTM B8-11 (2011) Standard Specification for Concentric-Lay-Stranded Copper Conductors, Hard, Medium-Hard, or Soft
 - c. Institute of Electrical and Electronics (IEEE)
 - d. IEEE 386 (2016) Separable Insulated Connector Systems for Power Distribution Systems Above 600V
 - e. IEEE 48 (2009) Test Procedures and Requirements For Alternating Current Cable Terminations 2.5 kV Through 765 kV
 - f. IEEE 404 (2012) Cable Joints for use with Extruded Dielectric Cable Rated 5000- 138,000V and Cable Joints for use with Laminated Dielectric Cable Rated 2500-500,000V
 - g. International Electrical Testing Association, Inc. (NETA)
 - h. NETA ATS (2013) Acceptance Testing Specifications for Electrical Power Distribution Equipment and Systems
 - i. National Fire Protection Association (NFPA)
 - j. NFPA 70 (latest version adopted) National Electrical Code
 - k. Occupational Safety and Health Administration (OSHA)

B. Definitions

- i. Medium voltage power cables shall mean all cables rated 1001 to 35,000 volts.

C. General Requirements

- i. Refer to Section 26 00 00 Electrical General Provisions as it applies to work specified in this section.

D. Submittals

- i. The following shall be submitted in accordance with the Standards. Reference Section 01 33 00 Submittal Procedures in sufficient detail to show full compliance with the specifications.
- ii. Test Reports: Submit test reports in accordance with the paragraph entitled, "Field Testing", of this section including insulation resistance test and direct-current high-potential test.

E. Qualifications of cable splicers shall be provided.

- i. Personnel performing splicing shall have a minimum of 5 years of experience in medium-voltage cable splicing and terminations of the type used in this project. Once a termination or splice has been started by a worker, the same person shall complete that particular splice. Each termination and splice shall be started and completed in one continuous work period.



2. PRODUCTS

- A. Splices
 - i. Splice kits shall be furnished by Owner and installed by Contractor.
- B. Terminations
 - i. All terminations shall be furnished by Owner and installed by the Contractor.
- C. Cable Pulling Lubricant
 - i. Polywater “Dyna-Blue” heavy duty cable pulling lubricant, or approved equal, shall be provided by Owner for Contractor’s use.
- D. Cable Cleaner
 - i. Shall be provided by Owner and installed by Contractor.
- E. Cable Tags in Manholes and at Terminations
 - i. Polyethylene Cable Tags
 - a. Provide tags of polyethylene that have an average tensile strength of 4500 pounds per square inch; and that are 0.035-inch thick, non-corrosive non-conductive; resistive to acids, alkalis, organic solvents, and salt water; and distortion resistant to 300 °F. Provide a one-piece nylon, self-locking tie at each end of the cable tag. Ties shall have a minimum loop tensile strength of 175 pounds. The cable tags shall have block letters, numbers, and symbols 1-inch high on a yellow background. Letters, numbers, and symbols shall not fall off or change positions regardless of the cable tags orientation.

3. EXECUTION

- A. Installation
 - i. Medium-voltage cables shall be installed in accordance with NFPA 70 (2020) National Electrical Code.
 - ii. Verify existing phasing and phase rotation at each interface with existing equipment. Provide qualified personnel and the appropriate medium and low voltage test equipment as required to safely perform this phasing. Match and maintain existing system phasing and phase rotation at each splice and termination.
 - iii. Cable shall be installed in underground duct banks and through manholes.
 - iv. Protection During Splicing Operations:
 - a. Waterproof protective coverings shall be available on the work site to provide protection against moisture while a splice is being made. Under no conditions shall a splice or termination be made with the interior of a cable exposed to moisture.
 - v. Duct Cleaning:
 - a. Ducts shall be thoroughly cleaned before installation of power cables.
 - b. A standard flexible mandrel shall be pulled through each duct to loosen particles of earth, sand, or foreign material in the conduit.
 - vi. Pulling Cables in Ducts and Manholes:
 - a. All cable pulling equipment and tools shall be provided by Contractor. Pulling equipment shall utilize steel cable, not ropes.
 - b. A pulling plan shall be submitted.
 - c. De-watering of manholes may be required. This shall be performed by the Contractor as needed.



- d. A sufficient number of trained personnel and equipment with two-way radio communication capability shall be employed to ensure the careful and proper installation of the cable.
- e. Cable reel shall be set up at the side of the manhole and above the duct, allowing the cable to enter through the opening, without reverse bending. Flexible tube guide shall be installed through the opening in a manner that will prevent the cable from rubbing on the edges of any structural member (manhole frame, duct, etc.).
- f. Two long-radius (30 inches minimum) quadrant block cable pulling sheaves and necessary jamb skid support shall be used at the pulling end to ensure that sidewall pressures during pulling will not be excessive. A dynamometer shall be used in the pulling line to ensure that the pulling force is not exceeded. The pulling force shall not exceed the smaller of allowable tension on pulling device, allowable tension of cable, or the tension which produces the allowable sidewall pressure.
- g. The allowable tension on the pulling device is 6500 pounds for pulling eyes and 1000 pounds for pulling grip (where allowed). The allowable tension on cable shall not exceed the value computed from the following equation:

$$TM = 0.008 \times N \times CM$$

Where:

TM = maximum allowable pulling tension in pounds

N = number of conductors in the cable

CM = cross-sectional area of each conductor in circular mils

- h. The allowable sidewall pressure is the smaller of 500 pounds per foot of bend radius or the cable manufacturer's recommended maximum value. The pulling plan submittal shall show the calculations for allowable tension and sidewall pressure as well as the anticipated tension and sidewall pressure for each pull in the project.
- i. Cable shall be unreeled from the top of the reel. Payout shall be carefully controlled. Cable to be pulled shall be attached through a swivel to the main pulling wire by means of a pulling eye.
- j. Pulling eyes shall be attached to the cable conductors of the 3-1/C circuit to prevent damage to the cable structure. The entire 3-1/C circuit must be pulled simultaneously.
- k. Minimum bending radius during cable pulling operations shall be 12 times cable diameter.
- l. Cables shall be liberally coated with a suitable cable-pulling lubricant provided by Owner as it enters the tube guide or duct. Grease and oil lubricants shall not be used. Nonmetallic sheathed cables shall be covered with wire-pulling compounds when required which have no deleterious effects on the cable. Rollers, sheaves, or tube guides around



- which the cable is pulled shall conform to the 30 inches minimum bending radius of the cable during the pulling operations.
- m. Cables shall be pulled into ducts at a speed not to exceed 50 feet per minute and not in excess of maximum permissible pulling tension specified by the cable manufacturer. Cable pulling using a vehicle shall not be permitted. Pulling operations shall be stopped immediately with any indication of binding or obstruction and shall not be resumed until such difficulty is corrected. Sufficient slack shall be provided for free movement of cable due to expansion and contraction.
 - n. Cable splices made up in manholes shall be firmly supported on cable racks. No cable splices shall be pulled in ducts. Cable ends shall overlap at the ends of a section to provide sufficient undamaged cable for splicing. Cables to be spliced in manholes shall overlap the centerline of the proposed joint by not less than 2 feet.
 - o. Cables cut in the field shall have the cut ends immediately sealed to prevent entrance of moisture with heat-shrinkable molded cable end caps.
- vii. Splices and Terminations: All splices and terminations will be performed by the Contractor.
- a. Splices shall be made in manholes. Splicing of cables shall be expedited to minimize exposure and cable deterioration.
 - b. The cable concentric neutral wires shall be connected across each side of the splice. Bare connections of concentric neutral wires shall be sealed via an additional outer covering. This outer covering shall consist of a heavy wall, heat shrinkable tubing containing adhesive material (mastic) that melts as heat is applied and the outer tubing shrinks to form a moisture-proof environmental seal. The splice shall meet the requirements of IEEE 404 for a 15kV rating and must be rated by the manufacturer for use on 15kV class feeder cable systems. The splice shall be of a cold shrink design that does not require any additional heat source installation. The cold shrink splice body must be of a molded design made of silicone rubber. The splice jacketing shall be of a cold shrink tubing made of EPDM rubber. Extra precautions shall be taken to seal around the exit area of the bare copper jumpers with an additional mastic per the splice manufacturer's recommendations.
 - c. Cable splices shall be field fabricated from splicing kits supplied by Owner and in accordance with the cable manufacturer's recommendations for the type, size, and electrical characteristics of the cable specified. Cable splices in manholes shall be located midway between cable racks on walls of manholes and supported with cable arms at approximately the same elevation as the enclosing duct.
 - d. Cable splices shall be installed on cable racks, which will minimize physical stress on the splice connections. Splices shall be supported at approximately the same elevation as the installed cable except where space limitations or existing cable length limitations make this method impractical or impossible.



- viii. Cable Tag Installation:
 - a. Install cable tags in each manhole and at each termination indicating MV circuit # and phase (A, B, or C). Install cable tags over the fireproofing and position the tags so that they are clearly visible without disturbing any cabling or wiring in the manholes and equipment.
- B. Field Testing
 - i. After the installation of power cables has been completed, including splices, joints, and terminations, and before the cable is energized, each medium voltage cable shall be subjected to field testing in accordance with NETA ATS and the following requirements.
 - ii. Test equipment, labor, and trained technical personnel shall be Contractor provided as necessary to perform the electrical acceptance tests.
 - iii. All tests shall be recorded on pre-approved forms.
 - iv. Arrangements shall be made to have tests approved by the Engineer.
 - v. Each power-cable installation shall be completely isolated from extraneous electrical connections at cable terminations and joints. Safety precautions shall be observed.
 - vi. Each power cable shall first be given an insulation resistance test using a meg-ohmmeter with a voltage output of at least 2,500-volts. Test shall be applied for a long enough time to fully charge the cable (no less than one minute). Readings shall be recorded as indicated on forms provided. Minimum reading shall be 5000 meg-ohms at an ambient temperature of 68 °F. Readings taken at other than 68 °F ambient temperatures shall be corrected accordingly.
 - vii. Upon successful completion of the insulation resistance test, the cable shall be subjected to a direct-current high-potential test. Maximum DC test voltage for new 15 kV cable shall be 40 kilovolts.
 - viii. The installed cable shall be tested in no less than four (4) separate sections in addition to an overall test for the entire length of cable after all splices and terminations are complete. Submit for approval by the Engineer a testing plan, indicating the proposed testing points at the pre-commencement meeting.
 - ix. All power sources for test equipment, including but not limited to generator power, shall be regulated so as to prevent voltage fluctuations.
 - x. Leakage current readings and voltage decay readings shall be recorded as indicated in NETA ATS (2013) Acceptance Testing Specifications for Electrical Power Distribution Equipment and Systems and the test report. Final acceptance shall depend upon the satisfactory performance of the cable under test. No cable shall be energized until recorded test data have been approved by the Engineer.
 - xi. Terminations shall be clean and dry and shall be tested per IEEE 48. Radiographic tests shall be performed on all terminations at the discretion of the Engineer to determine if voids exist in the termination. Unacceptable cable, splices, or terminations shall be reworked at no additional expense to the Owner.



26 05 19
LOW-VOLTAGE ELECTRICAL
POWER CONDUCTORS AND CABLES

1. GENERAL

A. Related sections:

- i. 26 00 00 – General Electrical Requirements
- ii. 26 05 33.13 – Conduit for Electrical Systems

2. PRODUCT

- A. All building power wiring shall be 600V copper, type THWN-2, THHN, or XHHW-2 with 90 °C (194 °F) temperature rating for both dry and wet applications.
- B. Metal Clad (MC) cables are not allowed except in the following limited situations:
 - i. MC cables are permitted to be installed in raised computer floors where utilized as air plenums.
 - ii. MC cables are only permitted at lengths of 6'-0" or less and only for use a final connection to light fixtures or fire alarm devices. Additionally, cables shall be properly supported.
 - iii. In some renovations, MC cables may be used in select situations pending prior variance approval in writing by the Project Manager.
- C. Conductors
 - i. Specified gauge sizes refer to American Wire Gauge (AWG) copper conductors. All wire and cable shall be of soft drawn, annealed copper having a conductivity of not less than 98% of that of pure copper. Each wire shall be continuous without weld, splice, or joint throughout its length, uniform in cross section, and free from flaws, scales, and other imperfections.
 - ii. No aluminum allowed.
 - iii. All conductors shall have 600-volt insulation.
 - iv. Conductors #10 AWG and smaller shall be solid.
 - v. Conductors larger than #10 AWG shall be stranded.
- D. All conductor connections/terminations for \leq 480V AC equipment shall be mechanically secure and electrically "solid" such as wire nuts, crimped full ring bolt-on terminals, split-bolt connectors, and bolted lugs. "Stab" or spring-loaded connectors are not acceptable. All such connectors shall be properly insulated for 600V AC. All motor junction box connections shall be insulated connectors by Burndy, Cooper, IlSCO, Polaris, Thomas & Betts, or other approved equal. Wire nut connections within motor connection junction boxes are not allowed.
- E. Color coding: Outer covering of new conductors shall be color coded to indicate phase, neutral and ground. Color-coded tapes shall not be permitted. Colors shall be as follows:
 - i. All grounding conductors: Green.
 - ii. 208Y/120V wye system (208V delta system shall have no neutral):

Phase A	Black
Phase B	Red
Phase C	Blue
Neutral	White



iii. 480Y/277V wye system (480V delta system shall have no neutral):

Phase A	Brown
Phase B	Orange
Phase C	Yellow
Neutral	Grey



26 05 26

GROUNDING & BONDING FOR ELECTRICAL SYSTEMS

1. GENERAL

- A. Related sections:
 - i. 26 00 00 – General Electrical Requirements
- B. Incoming building service shall be grounded per NEC. In most buildings, the power system is either 208Y/120V wye or 480Y/277V wye solidly grounded. 240/120V single phase services with grounded center tap neutrals are common in student apartments and fraternity housing.
- C. All buildings' electrical services shall be provided with a grounding grid. The building main water service pipe shall not be used solely as the main grounding electrode. Dependent upon project requirements, "grid" may be as simple as a three 10'-0" long x ¾" diameter copper clad steel ground rod triad with each ground rod buried a minimum 2'-0" below finished grade and spaced 10'-0" apart horizontally forming an equilateral triangle, or a ground ring consisting of a buried bare, tinned copper grounding conductor connected to ground rods spaced 20'-0" on center around the perimeter of the building, and all vertical structural steel columns, re-bars of the foundation, incoming water service pipe within 5'-0" of its building entrance, etc. A separate grounding ring around the utility transformer pad shall be installed for the medium voltage side of a new building service (utility) transformer. It shall be separate from the building service grounding grid. Typically, a minimum of two separate grounding electrode grids shall be installed. If for any reason the Design Professional needs to specify less than the two separate grounding grids, contact Project Manager.
- D. All grounding connections between grounding electrodes and grounding electrode conductors shall have exothermic welds.
- E. For new facilities, at least one grounding test well shall be provided for each grounding grid.
- F. It is undesirable to have grounding electrode systems buried under concrete, but if the grounding electrode system must be buried under concrete, a test well for each ground rod buried under concrete shall be provided. In this case only, the top of ground rods shall be a minimum 12 inches below finished grade, but the grounding electrode conductors shall still be routed down and away from the ground rods at a minimum of 24 inches below finished grade. The test well shall have a minimum 12 inches inside diameter for unobstructed access to ground rods buried 12 inches below finished grade and a screw down cap. It shall have a length of 24 inches and slotted up to at least 12 inches below finished grade on at least two sides for grounding electrode conductor entry / exit. Leave a minimum of 3 inches of the top of each ground rod exposed (but still 12 inches below finished grade to top of ground rod) for ease of testing / maintenance access. The test well(s) shall be traffic rated in traffic areas.
- G. If there is a buried ground ring around the entire building, each of the perimeter steel columns in new buildings shall be bonded to its own ground rod with a #4/0 AWG bare, stranded, tinned, copper grounding electrode conductor down lead with the ground rod buried a minimum of 2 feet below finished grade, and a minimum 3 feet off the face of the building foundation. If buried under concrete, these ground rods shall have a test well as previously described.



- H. All grounding electrode system underground (buried) bare copper wire shall be tinned.
- I. Any grounding resistance test with less than 25 ohms (per NEC) shall not be acceptable.
- J. For “isolated grounded” receptacles, the ground conductors shall be connected to the dedicated grounding electrode and not connected to the building grounding system.
- K. All motors driven by VSD’s (VFD’s) shall have shaft grounding rings, and shall be grounded to their source equipment grounding conductor with no more than 25 ohms in resistance measurement.
- L. Provide emergency generator with a separate ground. UGA switches the neutral at the automatic transfer switches (3 pole ATS vs. 4 pole ATS). Refer to National Electrical Code section 250.30, regarding separately derived systems.
- M. All grounding electrode connections to equipment shall be with a 2-hole lug.



26 05 33.13
CONDUIT FOR ELECTRICAL SYSTEMS

1. GENERAL

A. Related sections:

- i. 26 00 00 – General Electrical Requirements
- ii. 26 05 19 – Low-voltage Electrical Power Conductors and Cables
- iii. 28 31 00 – Fire Detection & Alarm

2. PRODUCTS

- A. Minimum conduit size shall be ¾-inch diameter.
 - i. Exception: ½-inch flexible metal conduit or Type AC or MC is permitted for flexible connections to lighting fixtures and fire alarm devices in maximum 6'-0" length.
 - ii. ½-inch conduit may be allowed in tight conditions in existing walls or ceilings; however, an approved variance is required from the Project Manager.
- B. Conduit for all fire alarm systems shall be red or painted red.
- C. All exposed conduit below 8' in back of house, work room areas, mechanical rooms, etc. shall be galvanized rigid steel.
- D. All underground low voltage (0V up to 1000V) service secondary and other conduits shall be schedule 40 PVC transitioning to galvanized rigid steel at all elbows to include vertical members penetrating grade, unless otherwise specified. It shall also be encased in minimum 2 inches of 3000 p.s.i. concrete cover around entire circumference of outer conduit(s) with minimum 2 inches concrete separation between the outer circumferences of each conduit.
- E. All underground primary (medium voltage) conduit shall be either 5-inch or 6-inch diameter (confirm with UGA PM) Schedule 40-Type EB PVC transitioning to galvanized rigid steel at turn-up or turn-down elbows to include vertical members penetrating grade encased in minimum 3 inches of 3000 p.s.i. concrete cover around the entire exterior of the outer conduits' circumferences with minimum 3" (three inches) concrete separation between the outer circumferences of each conduit. Steel reinforcing bars for concrete duct bank shall be required in certain circumstances depending on the path of the duct bank itself (beneath vehicular traffic-rated areas, railroad tracks, etc.).
- F. All underground conduits either turning upward or downward shall transition to galvanized rigid steel (galvanized rigid steel elbows) if not in concrete duct bank.
- G. Set-screw fittings are not allowed for conduit connections. As a minimum, EMT and IMC conduits shall have compression connection fittings, and all galvanized rigid steel conduit connections shall be threaded.



26 05 43

UNDERGROUND DUCTS AND RACEWAYS FOR ELECTRICAL SYSTEMS

1. GENERAL

A. Related sections:

- i. 26 00 00 – General Electrical Requirements
- ii. 26 20 00 – Low Voltage Transformers
- iii. 26 56 00 – Exterior Lighting
- iv. 33 71 19 – Electrical Underground Ducts & Manholes
- v. 33 72 00 – Pad-Mount Utility Transformers

2. PRODUCTS

- A. All medium voltage duct banks for main feeders shall be 6-inch diameter (minimum conduit size may be minimum 5-inch diameter for other cases) schedule 40-Type A or EB PVC transitioning to galvanized rigid steel at turn-up or turn-down elbows to include vertical members penetrating grade, with minimum 3 inches of 3000 psi. or greater concrete encased around the exterior of the duct bank, and 3 inches of concrete between the outer circumference of each conduit. Design for duct bank spacers every five (5) linear feet. No exceptions are allowed. If top of duct has to be less than 18-inches below finished grade, the top of the duct bank shall have a minimum of 4-inches of concrete cover.
- B. Duct banks crossing under vehicular traffic-rated areas and railroad tracks shall be reinforced with steel reinforcing bars (rebar) as required by Georgia Department of Transportation Standards.
- C. Provide and install a minimum of 1250 lb. test polyester pull tape in each empty conduit leaving a minimum of 4 feet excess for each pull-string at each end.
- D. The largest practicable radii for commercially available conduit elbows shall be used, and in all cases shall exceed the minimum radii to which the conduit can be bent without mechanically degrading the performance of the conduit per manufacturer recommendations.
- E. Concrete duct banks shall be natural (unpainted and untinted) concrete color, unless top of duct bank is less than 18" below finished grade, which will require duct bank concrete to contain a red dye to a concentration that renders the concrete to be visibly red, and not just a faint tint.

3. EXECUTION

- A. Slope duct away from building entrances.



26 09 23
LIGHTING CONTROL DEVICES

1. GENERAL

A. Related sections:

- i. 26 00 00 – General Electrical Requirements
- ii. 26 09 36 – Modular Dimming Controls
- iii. 26 09 43.16 – Addressable Fixture Lighting Control
- iv. 26 51 00 – Interior Lighting

2. PRODUCTS

- A. All lighting control devices shall be manufactured by Lithonia Lighting Acuity Brands, Lutron, or Wattstopper.

3. EXECUTION

A. Occupancy based lighting controls system commissioning.

- i. Upon completion of the installation, the system shall be completely commissioned by the manufacturer's factory authorized technician who will verify all adjustments and sensor placement to ensure a trouble-free occupancy-based lighting control system.
- ii. The manufacturer's factory authorized technician, shall upon completion of the commissioning, provide a written report to the Contractor, Design Professional, and Project Manager indicating satisfactory completion of the Work. This report shall also indicate any corrective actions required on the part of the Contractor.



26 09 36
MODULAR DIMMING CONTROLS

1. GENERAL

A. Related sections:

- i. 26 00 00 – General Electrical Requirements
- ii. 26 09 23 – Lighting Control Devices
- iii. 26 09 43.16 – Addressable Fixture Lighting Control
- iv. 27 41 00 – General Audio-Visual Systems Requirements
- v. 27 41 00.01 – Audio-Visual Control Systems
- vi. 26 51 00 – Interior Lighting

B. Classroom Automated Lighting Presets Minimum: All classrooms shall have the following minimum presets as listed below. Refer to Section 27 41 00.01 Audio-Visual Control Systems for detailed information on audio-visual touch panel interface requirements with lighting. All classrooms shall have dimmable fluorescents or dimmable LEDs with low voltage or wireless addressable controls. For classroom lighting presets, refer to Section 26 09 36 Modular Dimming Controls and Section 27 41 00.01 Audio-Visual Control Systems. Strategic zone switching (especially in smaller classrooms) may be approved through the variance process. Lighting systems shall operate independently from audio-video presentation systems, even when integrated together. The information is general guidance as to the recommended lighting configuration for each preset, but does not include and is not intended to specify every aspect of the required setting. Through the Project Manager, coordinate with the UGA Center for Teaching and Learning as needed.

i. Preset / Scene 1 – Full On

- a. All light fixtures ON
- b. All dimmable fixtures set at full brightness

ii. Preset / Scene 2 – Normal Projection Mode

- a. Fixtures in front third of room OFF.
- b. Any other fixtures in the room which produce noticeable wash on the projection screens should be OFF.
- c. Any spot lights or down lights which illuminate the instructors podium should be full on, unless they produce a noticeable wash on the projection screen in which case they should be dimmed or turned off.
- d. The lighting in rear two-thirds of room should be set to be comfortable for reading and writing but not overpowering the image of the video projection system. Options are as follows:
 - 1) If none of the fixtures in the room are dimmable then turn on half of the fixtures in the rear two-thirds of the room.
 - 2) If all of the fixtures in the room are dimmable then set them at a reasonable level (eg. 60%).
 - 3) If there are a combination of dimmable and non-dimmable circuits then choose a combination which is comfortable for reading and writing but not overpowering the projector image.

iii. Last Preset / Scene – All Off

- a. ALL Fixtures in room OFF



- b. There should be a delay from when this button is hit to when the lights are fully off. The delay should be long enough to allow the user to exit the room before the lights are fully off.
 - C. Presenter Mode – For classrooms with whiteboard or blackboard behind projector screen.
 - i. Preset / Scene 3 – Presenter Mode
 - a. Fixtures in front third of room FULL ON.
 - b. Any spot lights or down lights which illuminate the instructors podium should be FULL ON.
 - c. Any spot lights illuminating the Whiteboard or Blackboard should be FULL ON.
 - d. The light fixtures in rear two-thirds of room should be set as described for Preset 2 above.
 - D. Movie Projector Mode
 - i. Preset / Scene 4 – Movie Projection Mode
 - a. Fixtures in front third of room OFF
 - b. ANY other fixtures in the room which produce noticeable wash on the projection screens should be OFF
 - c. The lighting in rear two-thirds of room should be set to be dim but with enough brightness to make it safe for audience members to walk in the aisles and stairways. Options are as follows:
 - 1) If none of the fixtures in the room are dimmable then turn on only the minimum number of fixtures in the rear two-thirds of the room.
 - 2) If all of the fixtures in the room are dimmable florescent lights then set them at the minimum dimming level allowed by the fixtures without flickering. Alternating fixture may also be turned completely off to provide a minimum safe level.
2. **PRODUCTS**
3. **EXECUTION**
- A. Test classroom settings with blackout shades and blinds closed to simulate nighttime usage.



26 09 43.16
ADDRESSABLE FIXTURE LIGHTING CONTROL

1. GENERAL

A. Related sections:

- i. 26 00 00 – General Electrical Requirements
- ii. 26 09 23 – Lighting Control Devices
- iii. 26 09 36 – Modular Dimming Controls
- iv. 26 51 00 – Interior Lighting
- v. 26 56 00 – Exterior Lighting

B. Relay output shall be clearly posted for future reference.

2. PRODUCTS

A. Acceptable manufactures are:

- i. Wattstopper Lighting Controls
- ii. Lithonia Lighting Acuity Brands
- iii. Lutron

3. EXECUTION

A. Training

- i. The Contractor shall include in the Cost of the Work or Bid sixteen (16) hours of on-site training and sixteen (16) hours of off-site technical support during the one-year warranty period. On-site training and off-site technical support requests will be initiated by and scheduled at the request of the Project Manager. End-User must be present at site during on-site training and off-site technical support sessions.



26 22 00
LOW-VOLTAGE DRY TYPE TRANSFORMERS

1. GENERAL

- A. Related sections:
 - i. 26 00 00 – General Electrical Requirements
- B. Transformers 30 kVA and smaller are allowed to be wall or ceiling mounted.
- C. Transformers larger than 30 kVA shall be floor mounted. If there are space restrictions, larger transformers can be ceiling hung from a “trapeze” type mounting arrangement or wall mounted only after providing signed and sealed documentation of evaluation by a Georgia registered structural engineer.

2. PRODUCTS

- A. Building transformers for outlets and lighting shall be dry type with copper windings and voltage adjustment taps: (Minimum two pluses and two minuses) +5%; +2.5%; center tap (0%); -2.5%; & -5%.
- B. Transformer efficiency shall meet the latest Department of Energy requirements. Low voltage dry-type transformers shall be high efficiency with copper windings and an 80 °C rise. If approved by Project Manager, a product up to a maximum of 115 °C rise can be selected. Aluminum windings may be specified on a case-by-case basis where weight is a concern with prior written variance approval from FMD engineering via the Project Manager.
- C. “K” rated transformers shall be specified where required (such as data centers, labs with highly sensitive electronic equipment, etc.). Their “K” rating shall be determined by the Design Professional on the basis of their application.



26 24 13

SWITCHGEARS AND SWITCHBOARDS

1. GENERAL

- A. Related sections:
 - i. 26 00 00 – General Electrical Requirements
- B. Switchgears or switchboards shall be provided for each incoming electrical service of 800 amperes or higher.

2. PRODUCTS

- A. Bus materials shall be copper or plated copper.
- B. All switchgears / switchboards shall contain a fully-rated neutral bus bar.
- C. Main overcurrent device shall be circuit breaker type. Fused disconnects are NOT acceptable.
- D. Breakers rated 800 amperes or higher shall be insulated case type with electronic tripping devices. Design Professional shall coordinate with FMD Engineering via the Project Manager for case-specific needs.
- E. Surge protection devices (transient voltage surge suppressors) and digital metering package shall be standard for all switchgears and switchboards. Automated Logic Controls (ALC) will provide a Veris “E50H5A” or equal power and energy meter with “U018” rope CT’s to be installed by the contractor in or adjacent to (in separate enclosure) the service switchgear / switchboard. It shall be programmed into the BAS by ALC.
- F. Design Professional shall coordinate with FMD Engineering via the Project Manager for case-specific needs for draw-out breakers.
- G. All switchgear / switchboard breakers shall be 100% rated, and each breaker shall have ground-fault protection.
- H. All switchgear / switchboard breakers rated for 400A (four hundred amps) or greater shall have electronic tripping devices.
- I. All switchgears / switchboards shall have short-circuit ratings greater than it’s short-circuit rating as determined by the Design Professional’s short-circuit analysis of the respective electrical system it is employed in.
- J. Acceptable manufacturers are Schneider/Square D, Eaton/Cutler - Hammer, and ABB/General Electric (ABB/GE). No exceptions.
- K. A breaker coordination study shall be performed on all new switchgear / switchboard installations to include all breakers downstream of the switchgear / switchboard as well. The instantaneous, long, short, and ground-fault time trip settings of each breaker shall be performed by the contractor and confirmed by the design and/or commissioning engineer prior to owner acceptance.

*Revised July
30, 2024*



26 24 16
PANELBOARDS

1. GENERAL

- A. Related sections:
 - i. 26 00 00 – General Electrical Requirements
- B. All panelboard circuit breakers shall be bolt-on type.
- C. All interior panelboard enclosures shall be equipped with “door-in-door” feature.
- D. All current limiting devices shall be circuit breakers. No fused switches are allowed.
- E. All electrical panelboard enclosures shall be NEMA rated for the environment in which they are specified to be installed. The Contractor is responsible for ensuring that this requirement is met and shall include related costs in the Base Bid or Cost of the Work.
- F. All panelboards shall have copper bus bars.
- G. Acceptable manufacturers are Schneider / Square D, Eaton / Cutler-Hammer, and ABB/General Electric (ABB/GE).
- H. All panelboards shall have a short-circuit rating greater than it’s short-circuit rating as determined by the Design Professional’s short-circuit analysis of the respective electrical system it is employed in.



26 24 19
MOTOR-CONTROL CENTERS

1. **GENERAL**

- A. Related sections:
 - i. 23 05 14 – Variable Frequency Drives
 - ii. 26 00 00 – General Electrical Requirements
- B. Low voltage (600V and below) motor control centers (MCC) shall be provided for motor starters, feeder breakers for variable speed drives (VSDs) and other electrical equipment where practical.

2. **PRODUCTS**

- A. The use of wall mounted starters shall be discouraged.
- B. All motor starters shall be across-the-line combination type with motor circuit protectors and hand-off-automatic (H-O-A) door switches with transformer type 'red' run indicating lights. Each motor starter shall also have a transformer type 'white' indicating light for overload condition (overload relay tripped).
- C. Control voltage shall be 120V or 277V.
- D. MCC bus materials shall be copper, tin-coated copper, or silver-plated copper.
- E. Minimum rating for vertical buses shall be 300 amperes unless otherwise specified on MCC one-line diagram. Horizontal main bus shall be fully rated for MCC and non-tapered.
- F. All bus rating shall be braced for greater than or equal to RMS short-circuit amperage as specified on MCC one-line diagram by the Design Professional's short-circuit analysis.
- G. Enclosure shall be NEMA 1 gasketed unless otherwise specified.
- H. Provide a continuous copper ground bus bar across the bottom of the MCC.



26 32 00
PACKAGED GENERATOR ASSEMBLIES

1. GENERAL

- A. Related sections:
 - i. 26 00 00 – General Electrical Requirements
 - ii. 26 05 26 – Grounding and Bonding for Electrical Systems
- B. Design Professional shall discuss with Project Manager to determine if the End-User requires a closed transition option.
- C. All new packaged generator installations require coordination of variances and EPA certifications. This coordination shall be initiated by the UGA Project Manager during the design phase with UGA Environmental Safety Division's Environmental Affairs Program (706) 542-5801 and shall involve the Design Professional.
- D. The Design Professional shall provide a detail for the generator pad (thickness, rebar, edges, etc.) in addition to any general information provided by the generator manufacturer.

*Revised July
30, 2024*

2. PRODUCTS

- A. The fuel source shall be natural gas. Diesel fuel is not allowed without UGA and Board of Regents approval.
- B. The emergency power shall be fed through dedicated panelboards via automatic transfer switches equipped with by-pass switches.
- C. Transfer switches installed in conjunction with new generator installations shall be 4-pole (switching neutral).
- D. Gas line capacity, line size, and pressure shall be confirmed by the natural gas provider for a given generator set.
- E. Provide either radiator mounted resistive load bank or separate pad mounted load bank as recommended by the generator manufacturer.
- F. Packaged generator assemblies shall be by Caterpillar, Cummins, Kohler, or Onan.
- G. New generators shall not be specified with attached load banks, however an extra spare 100% circuit shall be provided on all new generators.



26 41 00
FACILITY LIGHTNING PROTECTION

1. GENERAL

- A. Related sections:
 - i. 26 00 00 – General Electrical Requirements
- B. Design Professional shall provide code documentation of whether or not facility lightning protection is required.
- C. For situations where it is not required, coordinate with Project Manager to confirm if lightning protection shall be included in the Project.
- D. If system is required, as a minimum, the system shall be installed in a manner that allows UL Certification to be obtained.



26 51 00
INTERIOR LIGHTING

1. GENERAL

- A. Related sections:
 - i. 00 00 13 – Designing Learning Environments
 - ii. 09 50 00 – Ceilings
 - iii. 26 00 00 – General Electrical Requirements
 - iv. 26 09 23 – Lighting Control Devices
 - v. 26 09 36 – Modular Dimming Controls
 - vi. 26 09 43.16 – Addressable Fixture Lighting Control
 - vii. 27 41 00 – General Audio-Visual Systems Requirements
 - viii. 27 41 00.01 – Audio-Visual Control System
- B. Design Professional shall provide reflected ceiling plan for demolition and new construction drawings for lighting design.
- C. Lighting level shall conform to minimum IES Standards, UGA Standards, and applicable codes.
- D. During the design phases, provide manufacturers' cut-sheets for basis of design of each proposed fixture to Project Manager for review and approval.
- E. Provide photometric analysis in footcandles for each space or area.
- F. Provide watts per square foot calculations for each space.
- G. Provide list to Project Manager of types of lamps selected for Project. For maintenance purposes, minimize the number of types of lamps if other than LED. The Lighting Fixture Schedule will suffice for this requirement.
- H. Locate fixtures so that maintenance of fixtures is not difficult and does not require a ladder over 20' tall or lift.
 - i. Light fixtures for stairwells shall not be placed so that access to the fixture must be from the stairs.
 - ii. Design Professional is required to submit documentation to the Project Manager and receive location approval of any light fixtures that will require a ladder over 20' tall or a lift to access fixtures.
 - iii. Light fixtures shall be installed so that all maintainable parts of the fixture are totally accessible.
- I. For occupancy based light sensors, the Design Professional shall review length of time setting requirements for deactivation of lights with the Project Manager.
- J. Interior light fixtures adjacent to exterior windows shall be circuited and controlled separately from light fixtures in the same room that are remote to the exterior windows. This is to allow light fixtures adjacent to windows to be turned down or off during times of sufficient interior natural light.
- K. Classroom Lighting
 - i. Proper lighting is an essential element of instructional spaces. Natural daylighting is encouraged, but must be easily controlled to allow for projected media to effectively be viewed by classroom occupants. Lighting needs are dependent upon classroom size, shape, whiteboard size, AV configuration, ceiling height, and window locations. It is important to ensure that the color temperature of light fixtures provided within each classroom is the same. 2' x 2'



- fixtures are preferable to 2' x 4' fixtures, because they provide more even light levels and are more flexible with other ceiling / plenum equipment, but this should be confirmed with the project manager on a project-by project basis.
- ii. It may be desirable to provide wall lighting in large tiered classrooms, as these classrooms are more likely to have high walls. Light fixtures that project light downward is preferred over fixtures that project light upward, as these fixtures reflect light off of the ceiling.
 - iii. Pendant lighting should be avoided in classrooms and presentation spaces to avoid blocking projection images.
 - iv. Classroom functional lighting zones:

Zone	Description	Average Foot Candle (fc) Guidelines	Comments
Zone 1	Main classroom lighting - student seating area: This zone should provide students adequate lighting to comfortably read and take notes in class.	Typical: 40-50 fc with 2:1 max.-to-min. ratio Projection Mode: 5-20 fc	Avoid light fixture and projected image conflict. Fixtures may be dimmable or have two lighting levels to be controlled by instructor.
Zone 2	Instruction area - front of classroom and lectern area. This zone should provide visibility of the markerboard, as well as other demonstration areas, when the room lights are at full intensity.	Typical: 40-50 fc with 2:1 max.-to-min. ratio	Markerboards should be evenly illuminated.
Zone 3	Non - projection markerboard wall -whiteboard that is not covered when the projection screen is in use. Lighting should allow the whiteboard to be utilized by the instructor while the projection screen is in use.	Typical: 40-50 fc with 2:1 max.-to-min. ratio Projection Mode: 20-35 fc	Ensure that the lighting in this area does not bleed over into the projection screen area.
Zone 4	Projection markerboard - board that is covered when the projection screen is in use. Use the same requirements as Zone 3 during non - projection mode.	Typical: 40-50 fc with 2:1 max.-to-min. ratio Projection Mode: 1-10 fc	Ensure that emergency lighting does not interfere with projected image.
Zone 5	Instructor workstation. The instructor should be able to read notes and use AV equipment during projection mode.	Typical: 40-50 fc with 2:1 max.-to-min. ratio Projection Mode: 20-35 fc	Projection mode light level may be achieved with task lighting.



- v. Lighting controls should be located near each entrance to the classroom, as well as on or near the instructor station. Switching to control lighting zones should be provided on or near the instructor station. When cost concerns prohibit the use of dimmable fixtures in classrooms, consider providing inboard / outboard switching to achieve the desired variable lighting scenarios.
- L. Design Professional is responsible for ensuring coordination of any pendant lighting with the projector screen to ensure there are no conflicts.
- M. Design Professional is responsible for ensuring control compatibility of lighting fixtures and accessories with the selected lighting control system.
- N. Downlighting shall be spaced at least 24" from textured (i.e. tiled) walls in order to mitigate the highlighting of tile lippage and other dimensional inconsistencies.

2. PRODUCTS

- A. Linear fluorescent tubes, when required by other than LED applications, shall be either T5 or T8; however, mixture of these types of lamps in one facility is not allowed.
- B. Offices, laboratories, and classrooms are typically furnished with 2' x 2' and/or 2' x 4' recessed fixtures (troffers). These fixtures shall be LED. Recessed fixtures shall be Philips "EvoGrid", "EvoKit", or approved equals. All new 2' x 2' troffers shall have an efficacy of greater than or equal to 110 lumens/Watt, and 2' x 4' troffers shall have an efficacy of greater than or equal to 130 lumens/Watt. See manufacturer's cut-sheets at end of this section for the 'EvoGrid' complete fixtures and the 'EvoKit' retro-fit kits for existing fluorescent troffers.
- C. All offices and laboratories shall have dimming systems and/or zoning switching, and/or inboard and outboard switching.
- D. All classrooms shall have dimmable LEDs with low voltage or addressable controls. For classroom lighting presets, refer to Sections 26 09 36 Modular Dimming Controls and 27 41 00.01 Audio-Visual Control Systems. Strategic zone switching (especially in smaller classrooms) may be approved through the variance process. Lighting systems shall operate independently from audio-video presentation systems, even when integrated together.
- E. All interior lighting shall have a color temperature of approximately 4000K. If the Design Professional has design reasons for other than 4000K it should be discussed with the Project Manager and a variance submitted in writing for approval. Refer to Section 26 56 16 Parking Lighting for color temperature requirements in parking garages.
- F. MR16 halogen lamps are not allowed.
- G. Incandescent lighting is not allowed.
- H. High-intensity discharge lighting is not allowed except in research applications where it is required, and will be requested by the Project Manager.
- I. LED fixtures: Refer to Section 26 56 00 Exterior Lighting. The section entitled 'LED Fixtures' applies to interior LED fixtures.
- J. Housing Projects only: coordinate with Project Manager and End User for acceptable fixture selections.

3. EXECUTION

- A. Warranty of LED Fixtures: UGA will seek written assurances from the manufacturer that the product will perform as claimed in terms of life.



- i. Provide a written five-year on-site replacement of material, fixture finish, and workmanship. On-site replacement includes transportation, removal, and installation of new products. Finish warranty must include warranty against failure or substantial deterioration such as blistering, cracking, peeling, chalking, or fading.
- ii. Provide a written five-year replacement material warranty for defective or non-starting LED source assemblies.
- iii. Provide a written five-year replacement material warranty on all power supply units (PSUs), which are the LED drivers.
- iv. Provide a written five-year replacement warranty for luminaires producing inadequately-maintained illuminance levels at end of warranty period, as prorated from levels expected at end of useful life. For example, a luminaire expected to produce 70% of initial lumens at 100,000 hours would be expected to last over 11 years (continuous operation), so levels would be expected to be at 87% of initial at end of five-year warranty period. Warranty must cover all light sources (LED package, LED array, or LED module) including, but not limited to the LED die, encapsulate, and phosphor. If the expected useful life of the luminaire system is not maintained, the manufacturer must replace the light source(s) or luminaire(s) as needed at no cost to the Owner.
- v. Owner may request an optional ten-year replacement warranty for inadequately-maintained illuminance levels, finish of luminaire, power-supply unit (PSU), or defective LED source assemblies. The terms of the extended warranty will be negotiated by the Owner and the luminaire manufacturer for an additional cost.



Signify Day-Brite 'EvoGrid' 2'x2' LED Troffer

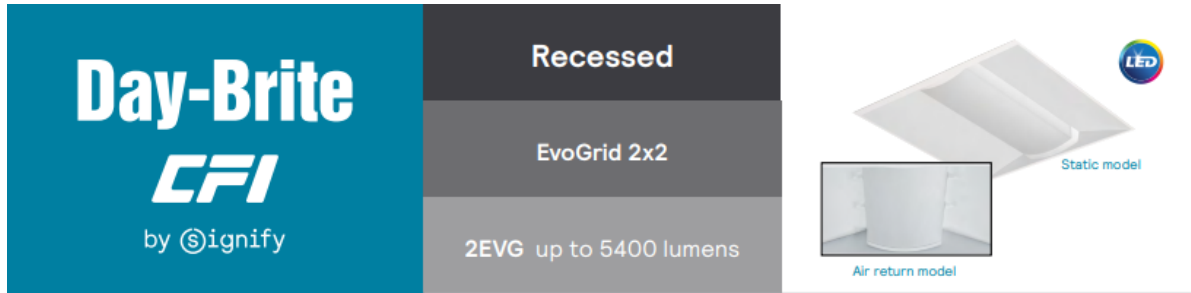

Day-Brite / CFI EvoGrid recessed utilizes highly reliable and efficient Philips LED platform boards and dimmable driver enabling market leading performance in its category. Its soft opal diffuser with large luminous area minimizes apparent brightness compared to other basket luminaires and provides general lighting perfect for a wide variety of applications.

Project: _____
 Location: _____
 Cat.No: _____
 Type: _____
 Lamps: _____ Qty: _____
 Notes: _____

Ordering guide - standard and wireless controls

example: 2EVG30L840-2-D-UNV-DIM

Width	Family	Ceiling Type	Air Function	Lumens (nominal delivered)	Color	Length	Center Diffuser	Voltage	Driver	Options
2	EV	G	Blank Static Air Return	30L 3000 38L 3800 45L 4500 54L 5400	830 80 CRI, 3000K 835 80 CRI, 3500K 840 80 CRI, 4000K 850 80 CRI, 5000K	2 2'	D Diffuse (opal) DS Diffuse smooth (opal) R Diffuse round ribbed (opal) RS Diffuse round smooth (opal)	UNV Universal Voltage, 120-277 volt 120 ³ 120V 277 ³ 277V 347 347V	DIM ¹ Dimming Step dimming to 40% input power SDIM ² MarkX phase dimming XDIM ³ MarkX phase dimming LDE Lutron LDES, 5% dimming DALI DALI	F1 3/8" flex, 3 wire 18 gauge 6' F2 3/8" flex, 4 wire 18 gauge 6' F1/D 3/8" twin flex, 3 wire 18 gauge 6' for dimmable luminaires F2/SW 3/8" single flex, 5 wire 18 gauge 6' for dimmable luminaires F2/6W 3/8" single flex, 6 wire 18 gauge 6' for dimmable and emergency luminaires GLR Fusing, fast blow ER100 ^{4,7} UL924 listed sensor bypass relay, factory installed between driver & sensor GTD/E ⁸ UL924 listed Bodine GTD factory installed on driver input GTD/SNSR ^{9,7} UL924 listed Bodine GTD installed between driver & sensor EMLED Integral emergency battery pack, 1100lm nominal (ballast enclosure on top of luminaire) DSC Quick driver disconnect SWZCS ^{1,4} Interact Pro scalable sensor with integral daylight & occupancy sensing, advanced grouping with dwell time SWZDT ¹ SpaceWise only sensor, daylighting and occupancy, advanced grouping with dwell time RADIO ³ Interact Pro RF sensor, enables wireless connected lighting control IAOSB ^{1,4} Interact Office advanced wireless sensor bundle, integral SC500 w/loT capabilities for enterprise scale projects CHIC Chicago Plenum rated CRM ¹ Continuous row mount TAP Top access plate AG Antimicrobial finish BAC ⁵ Meets the requirements of the Buy American Act of 1933 (BAA)

- Integral controls options dimmable to 5% via wireless all switch. Non-controls configurations are 0-10V dimmable to 1%.
- XDIM requires 120V or 277V specification.
- Specify only with -DIM driver option.
- Must order IRT9015 Interact commissioning remote with each system order.
- CRM includes side cover with top access plate and additional end cover, 7/8" gap between fixtures.
- Must be installed in conjunction with a UL1008 device.
- Must be ordered with an integral controls option.
- Failure to properly select the "BAC" suffix could result in you receiving product that is not BAA compliant product with no recourse for an RMA or refund. This BAC designation hereunder does not address (i) the applicability of, or availability of a waiver under, the Trade Agreements Act, or (ii) the "Buy America" domestic content requirements imposed on states, localities, and other non-federal entities as a condition of receiving funds administered by the Department of Transportation or other federal agencies.
- Consult Signify to confirm whether specific accessories are BAA-compliant.

Accessories⁹ (order separately)

- FMA22 - 2'x2' "F" mounting frame for NEMA "F" mounting
- EVD2L - EvoGrid 2'x2' rectangular ribbed replacement lens
- EVD52L - EvoGrid 2'x2' rectangular smooth replacement lens
- EVR2L - EvoGrid 2'x2' round ribbed replacement lens
- EVR52L - EvoGrid 2'x2' round smooth replacement lens
- FSK22 - 2'x2' surface mount field installation kit (factory welded seams), order with -TAP (top access plate option) (EMLED option not available)
- FSF22 - 2'x2' surface mount field assembly kit, order with -TAP (top access plate option) (EMLED option not available)

SWZCS accessories⁹ (order separately)

- IRT9015 - handheld remote for grouping and configuration(at least one remote required for any SWZCS installation).
- UID8451/10 - Wireless Dimmer Switch Selector
- UID8461/10 - Wireless Scene Selector

General Notes

- All options factory installed.
- All accessories are field installed.
- Many luminaire components, such as reflectors, refractors, lenses, sockets, lamp holders, and LEDs are made from various types of plastics which can be adversely affected by airborne contaminants. If sulfur based chemicals, petroleum based products, cleaning solutions, or other contaminants are expected in the intended area of use, consult factory for compatibility.





Signify Day-Brite `EvoGrid` 2`x4` LED Troffer

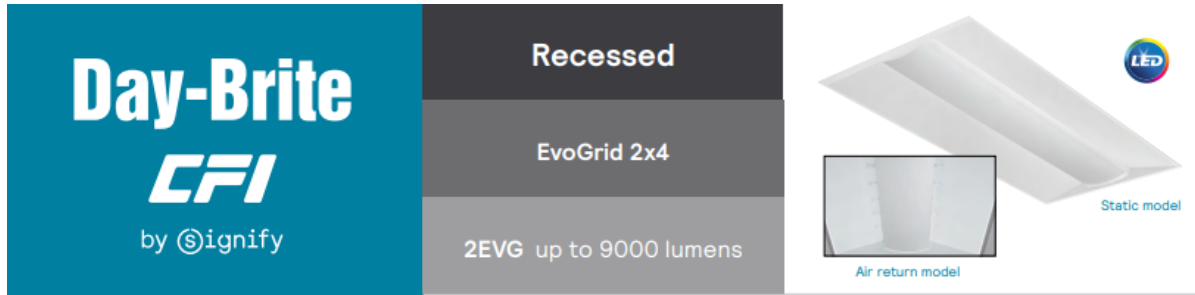

Day-Brite / CFI EvoGrid recessed utilizes highly reliable and efficient Philips LED platform boards and dimmable driver enabling market leading performance in its category. Its soft opal diffuser with large luminous area minimizes apparent brightness compared to other basket luminaires and provides general lighting perfect for a wide variety of applications.

Project: _____
Location: _____
Cat.No: _____
Type: _____
Lamps: _____ Qty: _____
Notes: _____

Ordering guide

example: 2EVG38L840-4-D-UNV-DIM

Width	Family	Ceiling Type	Air Function	Lumens (nominal delivered)	Color	Length	Center Diffuser	Voltage	Driver	Options
2	EV	G	blank Static H Air Return	30L 3000 38L 3800 43L 4300 48L 4800 54L 5400 74L 7400 85L 8500 90L 9000	830 ¹ 80 CRI, 3000K 835 80 CRI, 3500K 840 80 CRI, 4000K 850 ¹ 80 CRI, 5000K	4 4'	D Diffuse (opal) DS Diffuse smooth (opal) R Diffuse round ribbed (opal) RS Diffuse round smooth (opal)	UNV Universal Voltage, 120-277 volt 120 ² 120V 277 ² 277V 347 347V	DIM ³ Dimming Step dimming to 40% input power SDIM ⁴ MarkX phase dimming LDE Lutron LDE5, 5% dimming DALI DALI	F1 3/8" flex, 3 wire 18 gauge 6' F2 3/8" flex, 4 wire 18 gauge 6' F1/D 3/8" twin flex, 3 wire 18 gauge 6' for dimmable luminaires F2/SW 3/8" single flex, 5 wire 18 gauge 6' for dimmable luminaires F2/W 3/8" single flex, 6 wire 18 gauge 6' for dimmable and emergency luminaires GLR Fusing, fast blow ER100 ^{5,6} UL524 listed sensor bypass relay, factory installed between driver & sensor GTD/E ⁶ UL524 listed Bodine GTD factory installed on driver input GTD/SNSR ^{6,7} UL524 listed Bodine GTD installed between driver & sensor EMLED Integral emergency battery pack, 1100lm nominal (ballast enclosure on top of luminaire) DSC Quick driver disconnect SWZCS ^{10,11} Interact Pro scalable sensor with integral daylight & occupancy sensing, advanced grouping with dwell time SWZDT ¹ Integral sensor, daylighting and occupancy, advanced grouping with dwell time RADIO ⁸ Interact Pro RF sensor, enables wireless connected lighting control IAOSB ^{10,11} Interact Office advanced wireless sensor bundle, integral SC1500 w/IoT capabilities for enterprise scale projects CHIC Chicago Plenum rated CRM ⁹ Continuous row mount TAP Top access plate AG Antimicrobial finish BAC ⁹ Meets the requirements of the Buy American Act of 1933 (BAA)

- 3000K and 5000K color temperatures available only on high efficacy configurations
- XDIM requires 120V or 277V specification.
- Integral controls options dimmable to 5% via wireless all switch. Non-controls are 0-10v dimmable to 1%.
- Consult factory for SDIM on 74L and 74LH packages.
- Specify only with -DIM driver option
- Must order IRT9015 Interact commissioning remote with each system order.
- CRM includes side cover with top access plate and additional end cover. 7/8" gap between fixtures.
- Must be installed in conjunction with a UL1008 device.
- Must be ordered with an integral controls option.
- Failure to properly select the "BAC" suffix could result in you receiving product that is not BAA compliant product with no recourse for an RMA or refund. This BAC designation hereunder does not address (i) the applicability of, or availability of a waiver under, the Trade Agreements Act, or (ii) the "Buy America" domestic content requirements imposed on states, localities, and other non-federal entities as a condition of receiving funds administered by the Department of Transportation or other federal agencies.
- Consult Signify to confirm whether specific accessories are BAA-compliant.

Accessories¹¹ (order separately)

- FMA24 - 2`x4` "F" mounting frame for NEMA "F" mounting
- EVD4L - EvoGrid 2`x4` rectangular ribbed replacement lens
- EVD54L - EvoGrid 2`x4` rectangular smooth replacement lens
- EVR4L - EvoGrid 2`x4` round ribbed replacement lens
- EVR54L - EvoGrid 2`x4` round smooth replacement lens
- FSK24 - 2`x4` surface mount field installation kit (factory welded seams), order with -TAP (top access plate) option (EMLED option not available)
- FSF24 - 2`x4` surface mount field assembly kit, order with -TAP (top access plate) option (EMLED option not available)

SWZCS accessories¹¹ (order separately)

- IRT9015 - handheld remote for grouping and configuration(at least one remote required for any SWZCS installation)
- UID8451/10 - Wireless Dimmer Switch Selector
- UID8461/10 - Wireless Scene Selector

General Notes

- All options factory installed.
- All accessories are field installed.
- Many luminaire components, such as reflectors, refractors, lenses, sockets, lamp holders, and LEDs are made from various types of plastics which can be adversely affected by airborne contaminants. If sulfur based chemicals, petroleum based products, cleaning solutions, or other contaminants are expected in the intended area of use, consult factory for compatibility.





Signify Day-Brite `EvoKit' 2'x4' LED Troffer Retro-Fit Kit



Philips EvoKit LED Retrofit kit gen 5 is an energy efficient LED alternative to traditional linear fluorescent troffers that also helps reduce maintenance costs due to its long lifetime. Simple construction helps decrease installation times offering an installed LED solution within minutes.

Products can be found on the DLC QPL by searching the 6 digit product number. Additional information can be found at www.philips.com/evokit.

Project: _____
 Location: _____
 Cat. No: _____
 Type: _____
 Lamps: _____ Qty: _____
 Notes: _____

EvoKit with 0-10V Dimming ordering guide

Product No. (6NC)	Description	Watts (W)	Volts (V)	Lumen Maintenance (hours) ²	Approx. Lumens (lm) ³	Color Temp. (K)	Efficacy (lm/W)
0-10V Dimming							
527978	EvoKit 2x2 21L 15W 835 UNV 0-10 G5	15W	120-277	70,000	2100	3500	140
527986	EvoKit 2x2 21L 14W 840 UNV 0-10 G5	14W	120-277	70,000	2100	4000	150
527994	EvoKit 2x2 21L 14W 850 UNV 0-10 G5	14W	120-277	70,000	2100	5000	150
528000	EvoKit 2x2 31L 22W 835 UNV 0-10 G5	22W	120-277	70,000	3100	3500	135
528018	EvoKit 2x2 31L 22W 840 UNV 0-10 G5	22W	120-277	70,000	3100	4000	141
528026	EvoKit 2x2 31L 22W 850 UNV 0-10 G5	22W	120-277	70,000	3100	5000	141
528455	EvoKit 2x2 31L 23W 935 UNV 0-10 G5	23W	120-277	70,000	3100	3500	135
528034	EvoKit 2X4 36L 25W 835 UNV 0-10 G5	25W	120-277	70,000	3600	3500	144
528042	EvoKit 2X4 36L 25W 840 UNV 0-10 G5	25W	120-277	70,000	3600	4000	144
528059	EvoKit 2X4 36L 25W 850 UNV 0-10 G5	25W	120-277	70,000	3600	5000	144
528067	EvoKit 2X4 42L 28W 835 UNV 0-10 G5	28W	120-277	70,000	4200	3500	145
528075	EvoKit 2X4 42L 28W 840 UNV 0-10 G5	28W	120-277	70,000	4200	4000	150
528083	EvoKit 2X4 42L 28W 850 UNV 0-10 G5	28W	120-277	70,000	4200	5000	150
528643	EvoKit 2X4 42L 32W 935 UNV 0-10 G5	32W	120-277	70,000	4200	3500	131
High Efficiency 0-10 V Dimming							
528091	Evokit HE 2x2 21L 14W 835 UNV 0-10 G5	14W	120-277	70,000	2100	3500	153
528109	Evokit HE 2x2 21L 13W 840 UNV 0-10 G5	13W	120-277	70,000	2100	4000	162
528125	Evokit HE 2x2 31L 21W 835 UNV 0-10 G5	21W	120-277	70,000	3100	3500	148
528133	Evokit HE 2x2 31L 20W 840 UNV 0-10 G5	20W	120-277	70,000	3100	4000	155
528141	Evokit HE 2x2 31L 20W 850 UNV 0-10 G5	20W	120-277	70,000	3100	5000	155
528158	Evokit HE 2x4 30L 19W 835 UNV 0-10 G5	19W	120-277	70,000	3000	3500	158
528166	Evokit HE 2x4 30L 19W 840 UNV 0-10 G5	19W	120-277	70,000	3000	4000	158
528174	Evokit HE 2X4 36L 22W 835 UNV 0-10 G5	22W	120-277	70,000	3600	3500	162
528182	Evokit HE 2X4 36L 22W 840 UNV 0-10 G5	22W	120-277	70,000	3600	4000	164
528208	Evokit HE 2X4 42L 26W 835 UNV 0-10 G5	26W	120-277	70,000	4200	3500	158
528216	Evokit HE 2X4 42L 26W 840 UNV 0-10 G5	26W	120-277	70,000	4200	4000	162
528224	Evokit HE 2X4 42L 26W 850 UNV 0-10 G5	26W	120-277	70,000	4200	5000	162
528232	Evokit HE 2X4 47L 31W 835 UNV 0-10 G5	31W	120-277	70,000	4700	3500	152
528240	Evokit HE 2X4 47L 30W 840 UNV 0-10 G5	30W	120-277	70,000	4700	4000	157
Step Dimming							
528299	Evokit HE 2x2 31L 22W 835 UNV STEP G5	22W	120-277	70,000	3100	3500	142
528307	Evokit HE 2x2 31L 21W 840 UNV STEP G5	21W	120-277	70,000	3100	4000	148
528315	Evokit HE 2X4 42L 28W 835 UNV STEP G5	28W	120-277	70,000	4200	3500	150
528323	Evokit HE 2X4 42L 28W 840 UNV STEP G5	28W	120-277	70,000	4200	4000	150

See footnotes on the last page. Contact for your Philips sales representative for availability and lead time
 * Made to stock product (Contact your Philips sales representative for stock availability and lead time).

Not all product variations listed on this page are DLC qualified. To ensure that a specific model is qualified, visit www.designlights.org/search





EvoKit LED retrofit kit gen 5

Buy American Compliant** Evokit with 0-10V Dimming Ordering Guide

Product No. (6NC)	Description	Watts (W) ¹	Volts (V)	Lumen Maintenance (hours) ²	Approx. Lumens (lm) ³	Color Temp. (K)	Efficacy (lm/W)
0-10 G5 BAC Ordering Guide							
*	EvoKit 2x2 21L 15W 835 0-10 G5 BAC	15W	120-277	70,000	2100	3500	140
	EvoKit 2x2 21L 14W 840 0-10 G5 BAC	14W	120-277	70,000	2100	4000	150
	EvoKit 2x2 21L 14W 850 0-10 G5 BAC	14W	120-277	70,000	2100	5000	150
	EvoKit 2x2 31L 22W 835 0-10 G5 BAC	22W	120-277	70,000	3100	3500	135
	EvoKit 2x2 31L 22W 840 0-10 G5 BAC	22W	120-277	70,000	3100	4000	141
	EvoKit 2x2 31L 22W 850 0-10 G5 BAC	22W	120-277	70,000	3100	5000	141
	EvoKit 2x2 31L 23W 935 0-10 G5 BAC	23W	120-277	70,000	3100	3500	135
	EvoKit 2X4 36L 25W 835 0-10 G5 BAC	25W	120-277	70,000	3600	3500	144
	EvoKit 2X4 36L 25W 840 0-10 G5 BAC	25W	120-277	70,000	3600	4000	144
	EvoKit 2X4 36L 25W 850 0-10 G5 BAC	25W	120-277	70,000	3600	5000	144
	EvoKit 2X4 42L 28W 835 0-10 G5 BAC	28W	120-277	70,000	4200	3500	145
	EvoKit 2X4 42L 28W 840 0-10 G5 BAC	28W	120-277	70,000	4200	4000	150
	EvoKit 2X4 42L 28W 850 0-10 G5 BAC	28W	120-277	70,000	4200	5000	150
	EvoKit 2X4 42L 32W 935 0-10 G5 BAC	32W	120-277	70,000	4200	3500	131
0-10 G5 HE BAC Guide							
*	Evokit HE 2x2 21L 14W 835 0-10 G5 BAC	14W	120-277	70,000	2100	3500	153
	Evokit HE 2x2 21L 13W 840 0-10 G5 BAC	13W	120-277	70,000	2100	4000	162
	Evokit HE 2x2 31L 21W 835 0-10 G5 BAC	21W	120-277	70,000	3100	3500	148
	Evokit HE 2x2 31L 20W 840 0-10 G5 BAC	20W	120-277	70,000	3100	4000	155
	Evokit HE 2x2 31L 20W 850 0-10 G5 BAC	20W	120-277	70,000	3100	5000	155
	Evokit HE 2x4 30L 19W 835 0-10 G5 BAC	19W	120-277	70,000	3000	3500	158
	Evokit HE 2x4 30L 19W 840 0-10 G5 BAC	19W	120-277	70,000	3000	4000	158
	Evokit HE 2X4 36L 23W 835 0-10 G5 BAC	23W	120-277	70,000	3600	3500	157
	Evokit HE 2X4 36L 22W 840 0-10 G5 BAC	22W	120-277	70,000	3600	4000	164
	Evokit HE 2X4 42L 26W 835 0-10 G5 BAC	26W	120-277	70,000	4200	3500	158
	Evokit HE 2X4 42L 26W 840 0-10 G5 BAC	26W	120-277	70,000	4200	4000	162
	Evokit HE 2X4 42L 26W 850 0-10 G5 BAC	26W	120-277	70,000	4200	5000	162
	Evokit HE 2X4 47L 31W 835 0-10 G5 BAC	31W	120-277	70,000	4700	3500	152
	Evokit HE 2X4 47L 30W 840 0-10 G5 BAC	30W	120-277	70,000	4700	4000	157
Step Dimming BAC Guide							
*	Evokit HE 2x2 31L 22W 835 UNV STEP G5 BAC	22W	120-277	70,000	3100	3500	142
	Evokit HE 2x2 31L 21W 840 UNV STEP G5 BAC	21W	120-277	70,000	3100	4000	148
	Evokit HE 2X4 42L 28W 835 UNV STEP G5 BAC	28W	120-277	70,000	4200	3500	150
	Evokit HE 2X4 42L 28W 840 UNV STEP G5 BAC	28W	120-277	70,000	4200	4000	150

* For Product No. and Model No. please contact Philips Account Manager

** Failure to properly select the "BAC" suffix could result in you receiving product that is not BAA compliant product with no recourse for an RMA or refund. This BAC designation hereunder does not address (i) the applicability of, or availability of a waiver under, the Trade Agreements Act, or (ii) the "Buy America" domestic content requirements imposed on states, localities, and other non-federal entities as a condition of receiving.



26 56 00
EXTERIOR LIGHTING

1. GENERAL

A. Related sections:

- i. 26 56 13 – Lighting Poles and Standards
- ii. 26 56 16 – Parking Lighting
- iii. 26 56 19 – Roadway Lighting
- iv. 26 56 29 – Site & Building Entry Lighting
- v. 26 56 33 – Walkway Lighting
- vi. 26 56 36 – Flood Lighting

B. Purpose

- i. The exterior lighting goal is to provide strategies which will ensure a consistently well-lit, safe and attractive campus. In addition, implementing these standardized specifications and practices will reduce light pollution and energy consumption campus-wide.
- ii. This lighting standard minimizes the problems created by improperly designed and installed outdoor lighting. It reduces problems with glare, sky glow, light trespass, and capitalizes on the reduction of energy and financial costs of outdoor architectural and landscape lighting.
- iii. Excessive glare can be troublesome and may cause safety problems. Light trespass reduces privacy, and higher energy use results in increased costs besides impacting the environment directly and indirectly. There is a need for a lighting Standard that recognizes the benefits of outdoor lighting and provides clear performance-based guidelines for its installation on UGA campuses. Appropriately regulated and installed outdoor lighting will contribute to the safety and welfare of the UGA community and greater Athens area.

C. General Campus Requirements

- i. Quality exterior lighting is achieved by providing light where it is most needed without creating glare. In this fashion, smaller lamp wattages can be used to achieve a desirable effect. Energy consumption, maintenance and capital equipment costs can be reduced without sacrificing visibility or aesthetics.
- ii. Technical design criteria includes basic requirements such as lighting levels (illuminance), uniformity of light and balance of brightness (luminance) in addition to comments on trespass, night sky pollution and glare control. The technical design criteria, including but not limited to luminance levels, shall not be exceeded without an approved written variance issued by the Project Manager. If the Design Professional's design does not meet the criteria in this document, the Design Professional shall incur charges (as a design error) to modify the installation to meet the requirements.
- iii. Design Professionals shall provide support documentation including photometric calculations, manufacturer's data sheets, and lighting fixture schedule(s). Refer to Section 26 51 00, under 1.C Lighting Fixture Schedules.
- iv. OUA recommends that Design Professionals be Lighting Certified by the National Council for Qualification of Lighting Professionals (NCQLP). The NCQLP has established the LC certification process, by which practitioners in lighting



- and related fields, through testing, demonstrate their knowledge and experience across the lighting profession.
- v. Fixture Selection: All outdoor light fixtures installed on UGA campuses shall be either selected from the product group specified in the Standards, or submitted as alternates with all supporting data to be approved by the Project Manager. Alternates proposed will however have to exhibit construction, optical characteristics, and lamping of comparable quality as a prerequisite for consideration.
 - vi. All exterior lighting fixtures shall be shown wired and circuited on either exterior lighting plans or as a part of electrical site plans. Lighting calculations shall be furnished to FMD for future references.
 - vii. Direct burial cables are not allowed. All underground wiring shall be in minimum 1-inch diameter Schedule 40 PVC conduits.
 - viii. All exterior lighting fixtures shall be controlled by individual photocells. Time clock and/or group photo controls (with or without lighting contactors) are permitted under special situations.
 - ix. All exterior lighting circuits shall be fed from lighting panels of the associated building. Tapping power from the building service transformer secondaries is not permitted.
 - x. Exceptions
 - a. Exceptions to this Standard include sports lighting, temporary lighting, lighting integral to historic structures, and emergency lighting.
 - b. Any exceptions to this standard shall be reviewed by OUA on a case-by-case basis.
 - xi. Prohibitions
 - a. Laser Source Light: The use of laser source light or any similar high intensity light projected above the horizontal shall not be permitted.
 - b. Searchlights: The operation of searchlights shall not be permitted.
 - c. Lamps: Low Pressure Sodium and High-Pressure Mercury Vapor Lamps in new installations shall not be permitted.
 - d. Uplighting of new building facades and new landscaping is not permitted.
- D. Design Guidelines
- i. Minimize light trespass and glare.
 - a. Light fixtures should be designed so that the light goes exactly where it is intended. Special care should be taken to include louvers, glare shields, or barn doors to the front of floodlight fixtures to prevent light pollution and direct glare. Extra light bouncing into the atmosphere interferes with the work of astronomers and can disrupt the neighboring buildings. Wherever possible, use cut-off or full-cutoff fixtures, as defined by the Illuminating Engineering Society of North America (IESNA).
 - ii. Avoid overly bright lighting.
 - a. The intent of lighting building entries and circulation areas is to enhance the best qualities of that building, not to become a "beacon" on campus. The brightest is not necessarily the best. Maintain a maximum



- average illuminance level of 1-3 footcandles on all horizontal surfaces, in accordance with the Ninth Edition of the IES Handbook, depending on application.
- iii. Use “white” LED light sources.
 - a. White LED light sources with a color temperature of 4000K are recommended for campus exterior lighting.
 - b. In the white light category, LED lighting is swiftly growing as a viable technology. Use of LED fixtures on the campuses must comply with minimum performance and warranty criteria in this document.
 - iv. Avoid “yellow” light sources.
 - a. Do not use LED fixtures with less than 4000K color temperature.
 - v. Design with maintenance in mind.
 - a. Light fixtures shall be mounted in accessible locations so that the lighting can be maintained regularly. Specify fixtures that have simple mechanisms for lamp changing and captive hardware.
 - vi. Connect lighting to a control system.
 - a. Due to the difference between summer and winter daylight hours, lighting shall be connected to a photocell to turn fixtures on and a time clock to turn them off. The use of a dimming system or building automation is allowed in special applications with the approval of the Project Manager.
 - vii. Design with efficiency in mind.
 - a. Use the smallest wattage lamp source available in any given application to meet the desired light levels specified in section D5 to minimize energy consumption. Do not, however, compromise desired light levels as outlined in D5 to achieve higher efficiency.
 - viii. Design with lamp color in mind.
 - a. Specify lamps with a high color rendering index (≥ 70 CRI for exterior fixtures and ≥ 80 CRI for interior fixtures) and a uniform color temperature. The UGA campus standard correlated color temperature (CCT) is 4000K.
 - ix. Design with safety in mind.
 - a. Safety and security are paramount in an exterior environment. Factors other than horizontal illuminance should be taken into consideration when considering lighting design for safety. Vertical illuminance, glare, color of light, uniformity, contrast, and heat are equally important in lighting design. The ratios of average-to-minimum and maximum-to-minimum illuminance and luminance values shall be as per current edition of the IESNA Handbook’s recommended standards.
 - b. Fixtures should be placed such that they cannot easily or readily be touched by individuals, but are easily accessible to maintenance personnel. No design will be accepted where light fixtures are located so as to not be easily accessible by maintenance personnel.
 - c. At locations with CCTV cameras, special attention must be paid to the illumination levels and distribution because a camera perceives its surrounding very differently from the human visual system. The CCTV



manufacturer and security consultant must be consulted for vertical and horizontal illuminance requirements as well as uniformity requirements for the system. There might also be a requirement of using fixtures with specific optical characteristics. The lighting should be specified and designed to adhere to these requirements.

- d. Compliance with the IES guidelines and the light levels prescribed in this document is required.

E. Required Light Levels

i. Pedestrian Walkways

- a. Refer to Sections 26 56 33 Walkway Lighting and 26 56 13 Lighting Poles and Standards.

ii. Bikeways and Roadways

- a. Refer to Sections 26 56 19 Roadway Lighting and 26 56 13 Lighting Poles and Standards.

iii. Surface Parking and Parking Garages

- a. Refer to Section 26 56 16 Parking Lighting.

iv. Site and Building Entry Lighting

- a. Refer to Section 26 56 29 Site and Building Entry Lighting.

v. Signage

- a. Signage lighting, when used, should comply with the following requirements:

- 1) Fixtures illuminating signage shall have precision optics so as not to throw light beyond the sign. Specify appropriate shielding accessories for the fixtures
- 2) Whenever possible, signage should be illuminated from above using shielded fixtures to restrict and avoid night sky light pollution.
- 3) Lamping shall be LED light sources of 4000K CCT, and ≥ 70 CRI (≥ 80 CRI for interior fixtures).
- 4) Illuminance values measured vertically on the signage surface should not exceed 20 footcandle average maintained, with a maximum-to-minimum ratio of 4:1. For special applications that might require higher illuminance levels, OUA shall be informed.
- 5) Fixtures used for signage applications should have lockable aiming, easy maintainability and wherever possible, integral transformers instead of remote (except in case of LEDs).

vi. Demonstration Of Compliance

- a. Point-by-point photometric plans (in footcandles) of these applications, using software such as AGI32 or Visual, shall be provided for Owner review upon request. Point-by-point spacing shall be determined by FMD Engineering via the Project Manager on the basis of the size of the area to be lit, and boundary restrictions such as light pollution, etc. The calculations shall consider all light loss factors – lamp lumen depreciation, luminaire dirt depreciation and ballast factors. In case of fluorescent lamping, light losses expected due to cold weather shall be



accounted for in the design/specification of the system. Justification for deviating from the Standards shall be submitted to the Project Manager during the design development phase.

F. LED Fixtures

i. Introduction

- a. Projected life of LED sources and luminaires is a key component to payback scenarios in the University's purchase evaluations; therefore, life claims provided by suppliers, typically 70% lumen maintenance at 50,000 hours or greater, needs to be verified.
- b. Along with this issue, LED luminaires and retrofit lamps are being produced by many companies with varied experience in the lighting industry. In order to ensure that any product reviewed for application on the UGA campuses meet a standard performance benchmark, the following requirements will have to be met by the manufacturer.
- c. Unless there is a very good reason for not adhering to these benchmarks, the product will not be considered suitable for the University.

ii. Materials and Fabrication

- a. Manufacturer of LED lighting systems shall utilize an advanced production LED binning process to maintain color consistency. All LED individual fixture types must be shipped at the same time and stored on-site to ensure that products have been produced from the same bin. Tolerances greater than 200K will not be acceptable.
- b. For exterior application, all white LED's shall have a color temperature of 4000K, and a color rendering index (CRI) of 70 or greater (≥ 80 CRI for interior fixtures).
- c. The LED fixtures shall be operated at constant and carefully regulated current levels. LEDs shall not be overdriven beyond their specified nominal voltage and current.
- d. High power LED fixtures shall be thermally protected using one or more of the following thermal management techniques: metal core board, gap pad, heat sinks and/or internal monitoring firmware. Junction temperature of LED shall not exceed LED chip manufacturer's recommendation.
- e. LED fixture housings shall be designed to transfer heat from the LED board to the outside environment.
- f. Where applicable, for wet location use, LED-based fixture itself shall be sealed, rated, and tested for appropriate environmental conditions, not accomplished by using an additional housing or enclosure.
- g. Fixtures used on the exterior building facades shall have a minimum IP65 rating. All LED fixtures and power/data supplies shall be provided by a single manufacturer to ensure compatibility.
- h. All LED fixtures (100% of each lot) shall undergo a minimum eight-hour burn-in test during manufacturing.



- i. All LEDs used in the LED fixture shall be high brightness and proven quality from established and reputable LED manufacturers in business for greater than 5 years.
- j. LED fixtures shall be UL / ETL Listed.
- k. Manufacturer shall be able to provide supporting documentation of the product meeting third party regulatory compliance. At the minimum, LM79 and LM80 test results shall be made available.
- l. Manufacturer shall provide optical performance, polar diagrams, and relevant luminance and illuminance photometric data based on test results from an independent testing lab.
- m. White LED sources must meet the following requirements:
 - 1) Luminaires must be rated for -40 °C to +50 °C operation
 - 2) D_{uv} tolerance of 0.001 ± 0.006
 - 3) Color Rendering Index (CRI): ≥ 80
 - 4) Luminaire manufacturer must submit reliability reports indicating that the manufacturer of the LED (chip, diode, or package) has performed JEDEC (Joint Electron Devices Engineering Council) reliability tests on the LEDs as follows:
 - i) High Temperature Operating Life (HTOL)
 - ii) Room Temperature Operating Life (RTOL)
 - iii) Low Temperature Operating Life (LTOL)
 - iv) Powered Temperature Cycle (PTMCL)
 - v) Non-Operating Thermal Shock (TMSK)
 - vi) Mechanical shock
 - vii) Variable vibration frequency
 - viii) Solder Heat Resistance (SHR)
- iii. Warranty of Led Fixtures: UGA will seek written assurances from the manufacturer that the product will perform as claimed in terms of life.
 - a. Provide a written five-year on-site replacement of material, fixture finish, and workmanship. On-site replacement includes transportation, removal, and installation of new products. Finish warranty must include warranty against failure or substantial deterioration such as blistering, cracking, peeling, chalking, or fading.
 - b. Provide a written five-year replacement material warranty for defective or non-starting LED source assemblies.
 - c. Provide a written five-year replacement material warranty on all power supply units (PSUs), which are the LED drivers.
 - d. Provide a written five-year replacement warranty for luminaires producing inadequately-maintained illuminance levels at end of warranty period, as prorated from levels expected at end of useful life. For example, a luminaire expected to produce 70% of initial lumens at 100,000 hours would be expected to last over 11 years (continuous operation), so levels would be expected to be at 87% of initial at end of five-year warranty period. Warranty must cover all light sources (LED package, LED array, or LED module) including, but not limited to the LED die, encapsulate, and phosphor. If the expected useful life of the



luminaire system is not maintained, the manufacturer must replace the light source(s) or luminaire as needed at no cost to the Owner.

- e. Owner may request an optional ten-year replacement warranty for inadequately-maintained illuminance levels, finish of luminaire, power-supply unit (PSU), or defective LED source assemblies. The terms of the extended warranty will be negotiated by the Owner and the luminaire manufacturer for an additional cost.
- iv. The following is a list of requirements for all LED light fixtures:
 - a. UL / ETL listed as a whole assembly.
 - b. Only accept fixtures with LED chips manufactured by Philips, Osram, GE, Nichia, Cree, Hitachi and Xicato.
 - c. Provide LM80 test results from the LED chip manufacturer showing minimum 6000 hours of test time, conducted by the chip manufacturer using bare LED chips.
 - d. Provide LM79 test results for the fixture for total lumen output, electrical characteristics, efficacy and color characteristics, conducted by the manufacturer of the fixture with LEDs installed in it.
 - e. Provide L70 test results guaranteeing a minimum 70% of initial lumens at 50,000 hours, at full current and ambient temperature of the room / application that the fixture is designed for.
 - f. Provide binning size of the LED chips. This indicates the amount of consistency and variation in color of the white LEDs. Recommended bin sizes are $\pm 25K$ for premium interior spaces, $\pm 75K$ for standard interior spaces and outdoor signage lighting, and $\pm 150K$ for outdoor area lighting.
 - g. Correlated Color Temperature (CCT) for the fixtures – UGA standard color temperature for interior & exterior lighting is 4000K, except for special applications.
 - h. Color Rendering Index (CRI) of minimum 70 for exterior and 80 for interior lighting fixtures.
 - i. Minimum 5-years warranty, see LED warranty section.

G. Definitions

Cutoff

A luminaire light distribution where the candela per 1000 lamp lumens does not numerically exceed 25cd (2.5 percent) at an angle of 90 degrees above nadir, and 100cd (10 percent) at a vertical angle of 80 degrees above nadir.

Fixture

The assembly that houses the lamp or lamps and can include all or some of the following parts: a housing, a mounting bracket or pole socket, a lamp holder, a ballast, a reflector or mirror, and/or a refractor or lens, and a light trespass shield if required.

Flood Light / Spot Light

Any light fixture or lamp that incorporates a reflector or a refractor to concentrate the light output into a directed beam in a particular direction.

Full Cutoff



A luminaire light distribution where zero candela intensity occurs at an angle of 90 degrees above nadir, and at all greater angles from nadir. Additionally, the candela per 1000 lamp lumens does not numerically exceed 100cd (10 percent) at a vertical angle of 80 degrees above nadir.

Fully Shielded Fixture

A lighting fixture constructed in such a manner that all light emitted by the fixture, either directly from the lamp or a diffusing element, or indirectly by reflection or refraction from any part of the luminaire, is projected below the horizontal as determined by photometric test or certified by the manufacturer. Any structural part of the light fixture providing this shielding must be permanently affixed.

Glare

Light emitting from a luminaire with an intensity great enough to reduce a viewer's ability to see, and in extreme cases causing momentary blindness.

High Pressure Sodium

A common lamp used to produce high intensity narrow spectrum light, typically described as "amber" or "yellow". One of the most efficient light producers.

IES

Illuminating and Engineering Society. The lighting industry's recognized technical authority on illumination.

Lamp

The component of a luminaire that produces the light (the bulb or LED board).

LED

Light Emitting Diode

Light Trespass

The shining of light produced by a luminaire beyond the boundaries of the property on which it is located.

Lumen

A unit of luminous flux. One footcandle is one lumen per square foot. For the purposes of this standard, the lumen-output values shall be the INITIAL lumen output ratings of a lamp.

Luminaire

A complete lighting system, and includes a lamp or lamps and a fixture.

Metal Halide

A common lamp used to produce high intensity broad spectrum light, typically described as "white".

Refractor

The clear or translucent "lens" containing the lamp. It can be made of glass or other polycarbonate compounds, and have a range of textures. Prismatic refractors are the most common, as they direct light in a more uniform, controlled manner.

Semi Cutoff

A luminaire light distribution where the candela per 1000 lamp lumens does not numerically exceed 50cd (5 percent) at an angle of 90 degrees above nadir, and 200cd (20 percent) at a vertical angle of 80 degrees above nadir.



2. PRODUCTS

- A. For Pedestrian Walkways, Bikeways, and Roadways – E1
See Section 26 56 13 Lighting Poles and Standards for Specifications.
 - E1.a. Fixture for Replacement of Existing Campus Fixtures on Poles (Metal Halide and Semi-Cutoff Classification with RACE optics)
 - E1.b. Fixture for New Construction Campus Fixtures on Poles (Metal Halide and Cutoff classification with SE optics)
 - E1.c. Fixture for New Construction Campus Fixtures on Poles (LED and Cutoff Classification)
 - E1.d. Pole for E1.a., E1.b., and E1.c.

- B. For Building Entries – E2
See Section 26 56 29 Site and Building Entry for Specifications.
 - E2.a. RAB Lighting LED Wallpacks – LED

- C. For Parking Surfaces – E3
See Section 26 56 16 Parking Lighting for Specifications.
 - E3.a. Parking Surface Fixture – LED
 - E3.b. Pole for E3.ab.

- D. For Parking Garages – E4
See Section 26 56 16 Parking Lighting for Specifications.
 - E4.a. Linear Fixture – CFL
 - E4.b. LED Retrofit For Fixture E4.a.
 - E4.c. Various Shapes Integral LED
 - E4.d. Linear Integral LED

- E. For Interior Grid Ceiling Recessed Fixtures – E4
See Section 26 56 16 Interior Lighting.
 - E4.a. Recessed Grid Lay Fixture (Troffer) – LED
 - E4.b. LED Retrofit For Fixture E4.a.



26 56 13

LIGHTING POLES & STANDARDS

1. GENERAL

- A. Related sections:
 - i. 00 73 01 – Sole Source / Sole Brand
 - ii. 26 56 00 – Exterior Lighting
 - iii. 26 56 16 – Parking Lighting
 - iv. 26 56 19 – Roadway Lighting
 - v. 26 56 29 – Site and Building Entry Lighting
 - vi. 26 56 33 – Walkway Lighting
- B. Concrete pole bases shall extend a maximum of 3” above finished grade in landscaped areas and be flush with finished grade in hardscape areas. On sloped grades within landscaped areas, the maximum of 3” above finished grade shall be on the highest elevation side of the land contour.

*Revised July 30,
2024*

2. PRODUCTS

- A. For Pedestrian Walkways, Bikeways, and Roadways – Series E1
- B. See following product cutsheets for additional specification information on Series E1:
 - E1.a. LED Fixture for Post Top Fixtures, New Construction, & Replacement of Existing.
 - E1.b. Pole for E1.a.
 - E1.c. LED Globe Fixture Replacement.
- C. Concrete pole bases shall extend minimum 2 inches above finished grade in hardscaped areas, and minimum 3 inches above finished grade in landscaped areas.



E1.a.

FOR PEDESTRIAN WALKWAYS, BIKEWAYS, AND ROADWAYS
LED Fixture for Post Top Fixtures, New Construction, & Replacement

University of Georgia (UGA) – E1.a. FOR PEDESTRIAN WALKWAYS, BIKEWAYS, AND ROADWAYS – G3

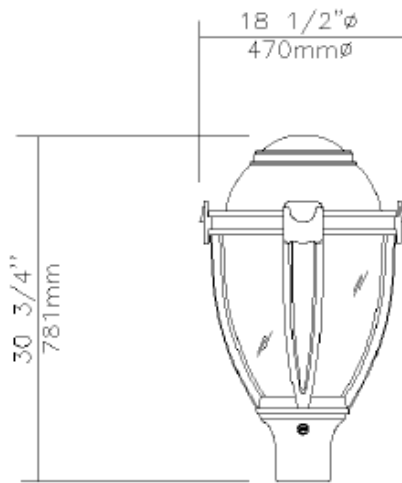

EPA: 1.76 sq ft / weight: 45 lb (20.5 kg)
Note: 3D image may not represent color or option selected.
Logos above include link, click to access.

Qty	1	Luminaire [L80-032]-[55W32LED4K-010]-G3-AC-CS-LE3/LE5-UNV-DMG-SF80-[PH7-001]-BKTX
-----	---	---

Description of Components:

Hood: A spun aluminum dome, mechanically assembled to the cast aluminum heat sink.

Guard: In a round shape with 4 arms, this guard is a one-piece cast 356 aluminum mechanically assembled to the fitter.

Access-Mechanism: A gravity die cast 356 aluminum frame with latch and hinge. The mechanism shall offer tool-free access to the inside of the luminaire. An embedded memory-retentive gasket shall ensure weatherproofing.

Heat Sink: Made of cast aluminum optimising the LEDs efficiency and life. Product does not use any cooling device with moving parts (only passive cooling device).

Globe: (AC-CS), Made of one-piece seamless injection-molded satin clear acrylic. The globe is assembled on the access-mechanism.

LED Module: Composed of 32 high-performance white LEDs. Color temperature as per ANSI/NEMA bin Neutral White, 4000 Kelvin nominal (3985K +/- 275K or 3710K to 4260K), CRI 70 Min. 75 Typical.

Optical System: (LE3/LE5), IES type III (asymmetrical) or IES type V (symmetrical). Distribution type to be coordinated per project design requirements with SESCO Lighting, Contact Thomas Nichols (tnichols@SESCOLighting.com). Composed of high performance UV stabilized optical grade polymer refractor lenses to achieve desired distribution optimized to get maximum spacing, target lumens and a superior lighting uniformity. **System is rated IP66.** Street-side indicated.



Driver: High power factor of 90% minimum. Electronic driver, operating range 50/60 Hz. **Auto-adjusting universal voltage input from 120 to 277 VAC rated for both application line to line or line to neutral, Class 1, THD of 20% max.** Maximum ambient operating temperature from -40F(-40C) to 130F(55C) degrees. **Driver comes with dimming compatible 0-10 volts.**

The current supplying the LEDs will be reduced by the driver if the driver experiences internal overheating as a protection to the LEDs and the electrical components. Output is protected from short circuits, voltage overload and current overload. Automatic recovery after correction. Standard built-in driver surge protection of 2.5kV (min).

Driver Options: (DMG), Dimming compatible 0-10 volts. For applicable warranty, certification and operation guide see Lumec dimmable luminaire specification document for unapproved device installed by other. To get document, click on this link: [Specification document](#) or go on web site on this address: https://www.signify.com/b-dam/signify/en-us/brands/lumec/Lumec-un-approved-control-device-installed-by-others-7_d.pdf

Surge Protector: Surge protector tested in accordance with ANSI/IEEE C62.45 per ANSI/IEEE C62.41.2 Scenario I Category C High Exposure 10kV/10kA waveforms for Line-Ground, Line-Neutral and Neutral-Ground, and in accordance with U.S. DOE (Department of Energy) MSSLC (Municipal Solid-State Street Lighting Consortium) model specification for LED roadway luminaires electrical immunity requirements for High Test Level 10kV / 10kA.

Fitter: Cast aluminum 356 c/w 4 set screws 3/8-16 UNC. Fits on a 4"(102mm) outside diameter by 4"(102mm) long tenon.

Luminaire Options: (PH7-001), Universal Photoelectric Cell, Button Type, 120V-277V.

Description of Components:

Wiring: Gauge (#14) TEW/AWM 1015 or 1230 wires, 6" (152mm) minimum exceeding from luminaire.

Hardware: All exposed screws shall be complete with Ceramic primer-seal basecoat to reduce seizing of the parts and offers a high resistance to corrosion. All seals and sealing devices are made and/or lined with EPDM and/or silicone and/or rubber.

Anchor Bolts: Anchor bolts made of ASTM F1554 grade 55 steel with a minimum yield strength of 55,000 psi. Nuts made of ASTM F1554-99 grade A steel or better. The thread adjustment is ANSI class 2B regardless of the diameter of the bolts. Washers made of ASTM grade F-844 steel or better. All galvanized parts are hot-dip galvanized with minimum requirement the ACNOR G-164 standard.

Finish: Color to be **black textured RAL9005TX (BKTX)** and in accordance with the AAMA 2603 standard. Application of polyester powder coat paint (4 mils/100 microns) with ± 1 mils/24 microns of tolerance. The Thermosetting resins provides a discoloration resistant finish in accordance with the ASTM D2244 standard, as well as luster retention in keeping with the ASTM D523 standard and humidity proof in accordance with the ASTM D2247 standard.

The surface treatment achieves a minimum of 2000 hours for salt spray resistant finish in accordance with testing performed and per ASTM B117 standard.

LED products manufacturing standard: The electronic components sensitive to electrostatic discharge (ESD) such as light emitting diodes (LEDs) are assembled in compliance with IEC61340-5-1 and ANSI/ESD S20.20 standards so as to eliminate ESD events that could decrease the useful life of the product.

Quality Control: The manufacturer must provide a written confirmation of its ISO 9001-2008 and ISO 14001-2004 International Quality Standards Certification.

Certification: The manufacturer will have to supply a copy of approval products certificate, CSA or UL.

Vibration Resistance: The L80 meets the **ANSI C136.31, 2010**, American National Standard for Roadway Luminaire Vibration specifications for Bridge/overpass applications. (Tested for 3G over 100 000 cycles)

Aluminum poles are not recommended in high vibration environments such as bridge, overpass, top of building, airport, train station, etc.

Mechanical resistance: This design information is intended as a general guideline only. The customer is solely responsible for proper selection of pole, luminaire, accessories and foundation under the given site conditions and intended usage. The addition of any other item to the pole may dramatically impact the wind load on that pole. It is strongly recommended that a qualified professional be consulted to analyze the loads given the user's specific needs to ensure proper selection of the pole, luminaire, accessories, and foundation. Lumec assumes no responsibility for such complete analysis or product selection. Failure to insure proper site analysis, pole selection, loads and installation can result in pole failure, leading to serious injury or property damage.



LED Wattage and Lumen Values: 4000K Contemporary Lantern (L80-L81)

Globe

Ordering Code	Total LEDs	System Current (mA)	Color Temp.	Average System Wattage (W)	Type LE2			Type LE3			Type LE4			Type LE5		
					Delivered Lumens	Efficacy (Lm/W)	BUG Rating	Delivered Lumens	Efficacy (Lm/W)	BUG Rating	Delivered Lumens	Efficacy (Lm/W)	BUG Rating	Delivered Lumens	Efficacy (Lm/W)	BUG Rating
L80-30W16LED4K-G3	16	700	4000	37	3206	87	B1-U3-G1	3196	86	B1-U3-G1	3184	86	B1-U3-G1	3169	86	B2-U3-G1
L80-35W32LED4K-G3	32	350	4000	36	3609	100	B1-U3-G1	3594	100	B1-U3-G1	3585	100	B1-U3-G1	3569	99	B3-U3-G1
L80-48W16LED4K-G3	16	1050	4000	54	4416	82	B1-U3-G1	4402	82	B1-U3-G1	4386	81	B1-U3-G2	4366	81	B3-U3-G1
L80-55W32LED4K-G3	32	530	4000	53	5247	99	B1-U3-G1	5229	99	B1-U3-G2	5211	98	B1-U3-G2	5187	98	B3-U3-G2
L80-70W64LED4K-G3	64	350	4000	68	7091	104	B1-U3-G2	7071	104	B1-U3-G2	7044	104	B1-U3-G2	7011	103	B3-U3-G2
L80-72W32LED4K-G3	32	700	4000	72	6560	91	B1-U3-G2	6539	91	B1-U3-G2	6517	91	B1-U3-G2	6487	90	B3-U3-G2
L80-80W48LED4K-G3	48	530	4000	80	7644	96	B2-U3-G2	7631	95	B1-U3-G2	7595	95	B1-U3-G2	7559	94	B3-U3-G2



E1.a with TN3 adapter tenon for legacy poles

University of Georgia (UGA) – E1.a. FOR PEDESTRIAN WALKWAYS, BIKEWAYS, AND ROADWAYS

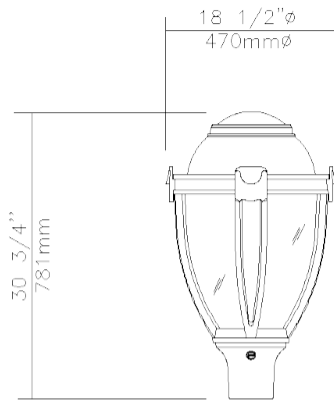

EPA: 1.76 sq ft / weight: 45 lb (20.5 kg)
Note: 3D image may not represent color or option selected.
Logos above include link, click to access.

Luminaire [L80-011]-72W32LED4K-T-AC-CS-LE3/LE5-UNV-DMG-SF80-[PH7-001]-TN3-BKTX

Description of Components:

Hood: A spun aluminum dome, mechanically assembled to the cast aluminum heat sink.

Guard: In a round shape with 4 arms, this guard is a one-piece cast 356 aluminum mechanically assembled to the fitter.

Access-Mechanism: A gravity die cast 356 aluminum frame with latch and hinge. The mechanism shall offer tool-free access to the inside of the luminaire. An embedded memory-retentive gasket shall ensure weatherproofing.

Heat Sink: Made of cast aluminum optimising the LEDs efficiency and life. Product does not use any cooling device with moving parts (only passive cooling device).

Globe: (AC-CS), Made of one-piece seamless injection-molded satin clear acrylic. The globe is assembled on the access-mechanism.

LED Module: LED type Philips Lumileds LUXEON T. Composed of 32 high-performance white LEDs. Color temperature as per ANSI/NEMA bin Neutral White, 4000 Kelvin nominal (3985K +/- 275K or 3710K to 4260K), CRI 70 Min. 75 Typical.

Optical System: (LE3/LE5), IES type III (asymmetrical) or IES type V (symmetrical). Distribution type to be coordinated per project design requirements with SESCO Lighting, Contact Thomas Nichols (tnichols@SESCOlighting.com). Composed of high-performance optical grade PMMA acrylic refractor lenses to achieve desired distribution optimized to get maximum spacing, target lumens and a superior lighting uniformity. Performance shall be tested per LM-63, LM-79 and TM-15 (IESNA) certifying its photometric performance. Street side indicated.

Driver: High power factor of 90% minimum. Electronic driver, operating range 50/60 Hz. **Auto-adjusting universal voltage input from 120 to 277 VAC rated for both application line to line or line to neutral, Class 1, THD of 20% max.** Maximum ambient operating temperature from -40F(-40C) to 130F(55C) degrees. **Driver comes with dimming compatible 0-10 volts.**



The current supplying the LEDs will be reduced by the driver if the driver experiences internal overheating as a protection to the LEDs and the electrical components. Output is protected from short circuits, voltage overload and current overload. Automatic recovery after correction. Standard built-in driver surge protection of 2.5kV (min).

Driver Options: (DMG), Dimming compatible 0-10 volts. For applicable warranty, certification and operation guide see "Philips Lumec dimmable luminaire specification document for unapproved device installed by other". To get document, click on this link: [Specification document](http://www.lumec.com/Lumec3DV2/PdfWebLink/Philips Lumec dimmable luminaire specification document for unapproved device installed by other.pdf) or go on web site on this address: <http://www.lumec.com/Lumec3DV2/PdfWebLink/Philips Lumec dimmable luminaire specification document for unapproved device installed by other.pdf>

Surge Protector: Surge protector tested in accordance with ANSI/IEEE C62.45 per ANSI/IEEE C62.41.2 Scenario I Category C High Exposure 10kV/10kA waveforms for Line-Ground, Line-Neutral and Neutral-Ground.

Fitter: Cast aluminum 356 c/w 4 set screws 3/8-16 UNC. Fits on a 4"(102mm) outside diameter by 4"(102mm) long tenon. (TN3), Transition tenon 4" (102mm) O.D. by 4" (102mm) long , mechanically fastened to the fitter, to be installed over a 3" (76mm) O.D. by 4" (102mm) long tenon.

Luminaire Options: (PH7-001), Universal Photoelectric Cell, Button Type, 120V-277V.

Hardware: All exposed screws shall be complete with Ceramic primer-seal basecoat to reduce seizing of the parts and offers a high resistance to corrosion. All seals and sealing devices are made and/or lined with EPDM and/or silicone and/or rubber.

Finish: Color to be **black textured RAL9005TX (BKTX)** and in accordance with the AAMA 2603 standard. Application of polyester powder coat paint (4 mils/100 microns) with ± 1 mils/24 microns of tolerance.

LED light engine technical information for L80 L81										
CRI = 70, CCT = 4000K (+/- 350K)										
System (LED + driver) rated life = 100,000 hrs ¹										
LED Module	Typical delivered lumens	Typical system wattage ² (W)	Typical current @ 120 V (A)	Typical current @ 208 V (A)	Typical current @ 240 V (A)	Typical current @ 277 V (A)	LED current (mA)	HID Replacement ³	Luminaire Efficacy Rating (lm/W)	BUG rating
72W32LED4K-T-LE2	5214	73	0.61	0.36	0.33	0.30	700	100W	71	B1-U3-G1
72W32LED4K-T-LE3	5177	72	0.61	0.36	0.33	0.30	700	100W	72	B1-U3-G2
72W32LED4K-T-LE4	5171	73	0.61	0.36	0.33	0.30	700	100W	71	B1-U3-G2
72W32LED4K-T-LE5	5272	73	0.61	0.36	0.33	0.30	700	100W	72	B3-U2-G2
80W48LED4K-T-LE2	6080	81	0.68	0.40	0.35	0.32	530	100W	75	B1-U3-G1
80W48LED4K-T-LE3	6044	81	0.68	0.40	0.35	0.32	530	100W	75	B1-U3-G2
80W48LED4K-T-LE4	6030	81	0.68	0.40	0.35	0.32	530	100W	74	B1-U3-G2
80W48LED4K-T-LE5	6148	81	0.68	0.40	0.35	0.32	530	100W	76	B3-U3-G2

1 L70 = 100,000 hrs (at ambient temperature = 25°C).

2 System wattage or total luminaire wattage includes the LED module and the LED driver.

3 Note: These guidelines show typical replacements for the HID wattage ranges shown. Replacements should always be confirmed with a photometric layout.

Note: Due to rapid and continuous advances in LED technology, LED luminaire data is subject to change without notice and at the discretion of Philips.



E1.b.
FOR PEDESTRIAN WALKWAYS, BIKEWAYS, AND ROADWAYS
POLE FOR FIXTURES E1.a.

- A. Note:
 - i. UGA has sole brand approval for this product.
- B. LUMEC R80A-12-TBC1-BKTX, 12'-0" overall height, traditional styled cast aluminum base, extruded fluted aluminum shaft, black textured powdercoat finish, 1/2 x 18 inches double nut double washer anchor bolts.
- C. See following page for cut sheet of approved pole.

University of Georgia (UGA) – E1.b. Pole for Fixture E1.a.

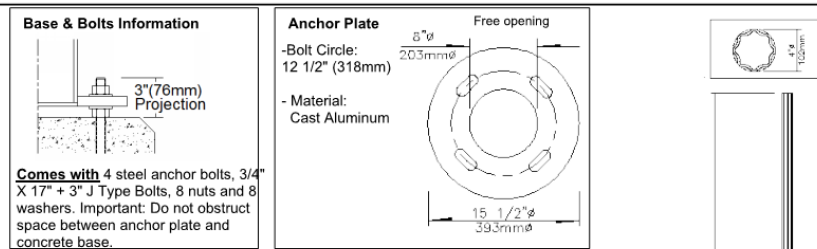

Qty	1	Pole	R80A-12-TBC1-BKTX
-----	---	------	-------------------

Description of Components:

Pole Shaft: Shall be made from a 4" (102mm) 8 fluted round extruded 6061-T6 aluminum tubing, having a 0.167" (4.2mm) wall thickness, welded to the pole base.

Joint Cover: One-piece round joint cover made from cast 356 aluminum, mechanically fastened with stainless steel screws.

Pole Base: Shall be made from a round fluted cast 356-T6 aluminum base having a 0.375" (9.5mm) wall thickness, complete with a cast-in anchor plate.

Maintenance Opening: The pole shall have a 4" x 9" (102mm x 229mm) maintenance opening centered 21" (533mm) from the bottom of the anchor plate, complete with a weatherproof cast 356 aluminum cover and a copper ground lug.

Base Cover: Two piece round base cover made from cast 356 aluminum, mechanically fastened with stainless steel screws.

IMPORTANT: Lumec strongly recommends the installation of the complete lighting assembly with all of its accessories upon the anchoring of the pole. This will ensure that the structural integrity of the product is maintained throughout its lifetime.

Hardware: All exposed screws shall be complete with Ceramic primer-seal basecoat to reduce seizing of the parts and offers a high resistance to corrosion. All seals and sealing devices are made and/or lined with EPDM and/or silicone and/or rubber.

Anchor Bolts: Anchor bolts made of ASTM F1554 grade 55 steel having a minimum yield strength of 55000 psi. Nuts made of ASTM A563 grade A steel or better. The thread fit is ANSI class 2B regardless of bolt diameter. Washers are made of ASTM grade F-844 or better steel. All galvanized parts are hot dip galvanized per ACNOR G-164 minimum.

Finish: Color to be **black textured RAL9005TX (BKTX)** and in accordance with the AAMA 2603 standard. Application of polyester powder coat paint (4 mils/100 microns) with ± 1 mils/24 microns of tolerance. The Thermosetting resins provides a discoloration resistant finish in accordance with the ASTM D2244 standard, as well as luster retention in keeping with the ASTM D523 standard and humidity proof in accordance with the ASTM D2247 standard.

The surface treatment achieves a minimum of 2000 hours for salt spray resistant finish in accordance with testing performed and per ASTM B117 standard.

Pole Weight: 49 lbs (22.3 kg)

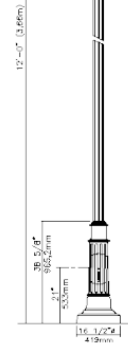



E1.c.
FOR PEDESTRIAN WALKWAYS, BIKEWAYS, AND ROADWAYS
FIXTURE FOR NEW CONSTRUCTION CAMPUS FIXTURES ON POLES
LED Globe Fixture Replacement.

University of Georgia (UGA) – E1.c. LED Globe Fixture Replacement

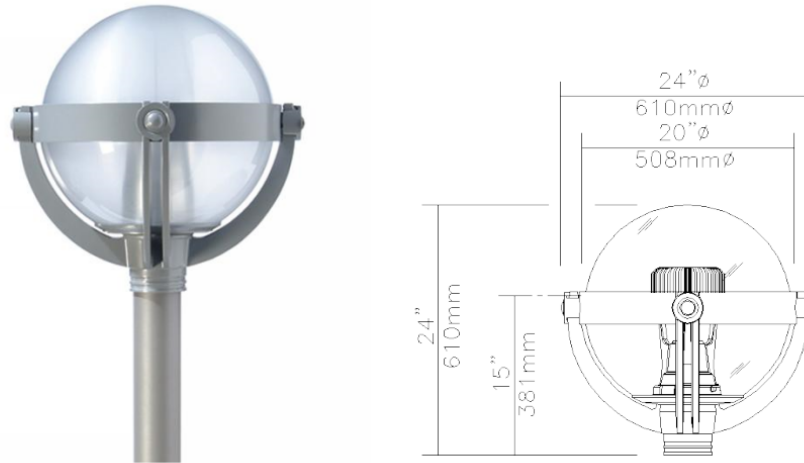

EPA: 1.99 sq ft / weight: 35.89 lb (16.3 kg)

Luminaire **NW-65W42LED4K-G2-ACDR-O-RLE5-VOLT-TN3-BRTX**

Description of Components:

Guard: In a round shape with 4 arms, this guard is a one-piece cast aluminum 356 with a decorative band, 3" (76mm) large x 1/8"(3mm) thick, and four medallions welded to the cage.

Access-Mechanism: Rotomatic, die-cast A360 aluminum quarter-turn mechanism with constant-pressure spring-loaded points. The mechanism shall offer tool-free access to the inside of the luminaire. An embedded memory-retentive gasket shall ensure weatherproofing. A red key on the unit shall indicate point of engagement.

Light Engine: EcoSwap Rotomatic tool-free system composed of 4 main components: **Heat Sink / LED Module / Optical System / Driver**
Electrical components are RoHS compliant.

Heat Sink: Made of extruded aluminum optimising the LEDs efficiency and life. Product does not use any cooling device with moving parts (only passive cooling device)

Globe: (ACDR-O) Made of one-piece roto molded opaline impact-resistant (DR) acrylic. The globe is mechanically assembled on the access mechanism.

LED Module: Composed of 42 high-performance white LEDs. Color temperature as per ANSI/NEMA bin Neutral White, 4000 Kelvin nominal (3985K +/- 275K or 3710K to 4260K), CRI 70 Min. 75 Typical.

09-13-2019





University of Georgia (UGA) – E1.c. LED Globe Fixture Replacement

Optical System: (RLE5), IES type V (symmetrical). Composed of high-performance acrylic refractor lenses to achieve optimized distribution and get maximum spacing. target lumens will create a perfect lighting uniformity. Performance shall be tested per LM-63, LM-79 and TM-15 (IESNA) certifying its photometric performance. Painted color grey.

Driver: High power factor of 90%. Electronic driver, operating range 50/60 Hz. **Auto-adjusting to a voltage between 120 and 277 volt AC rated for both application line to line or line to neutral, Class 2**, THD of 20% max. Maximum ambient operating temperature from -40F(-40C) to 130F(55C) degrees. Assembled on a unitized removable tray with Tyco quick disconnect plug resisting to 221F(105C) degrees.

The current supplying the LEDs will be reduced by the driver if the internal driver temperature exceeds 185F(85C), as a protection to the LEDs and the electrical components. Output is protected from short circuits, voltage overload and current overload. Automatic recovery after correction.

Surge Protector: Surge protector tested in accordance with ANSI/IEEE C62.45 per ANSI/IEEE C62.41.2 Scenario I Category C High Exposure 10kV/10kA waveforms for Line-Ground, Line-Neutral and Neutral-Ground, and in accordance with U.S. DOE (Department of Energy) MSSLC (Municipal Solid-State Street Lighting Consortium) model specification for LED roadway luminaires electrical immunity requirements for High Test Level 10kV / 10kA.

Fitter: Cast aluminum 356 c/w 4 set screws 1/4-20 UNC. Slip-fits on a 4"(102mm) outside diameter x 4" (102mm) long tenon. **(TN3)**, Transition tenon 4" (102mm) O.D. by 4" (102mm) long , mechanically fastened to the fitter, to be installed over a 3" (76mm) O.D. by 4" (102mm) long tenon.

Finish: Color to be **bronze textured (BRTX)** and in accordance with the AAMA 2603 standard. Application of polyester powder coat paint (4 mils/100 microns) with ± 1 mils/24 microns of tolerance.

LED Wattage and Lumen Values: 4000K

Clear Globe				RLE3			RLE5		
Ordering Code	Total LEDs	LED current (mA)	Average system watts (W)	delivered lumens	Efficacy (LPW)	BUG rating	delivered lumens	Efficacy (LPW)	BUG rating
40W42LED4K-G2-C	42	333	50	4830	96.2	B1-U3-G2	4845	96.5	B3-U3-G1
65W42LED4K-G2-C	42	500	70	6341	90.3	B2-U3-G2	6555	93.4	B3-U3-G2

Satin Clear Globe				RLE3			RLE5		
Ordering Code	Total LEDs	LED current (mA)	Average system watts (W)	delivered lumens	Efficacy (LPW)	BUG rating	delivered lumens	Efficacy (LPW)	BUG rating
40W42LED4K-G2-CGB	42	333	50	4135	82.3	B1-U3-G2	4156	82.7	B2-U3-G2
65W42LED4K-G2-CGB	42	500	70	5348	76.2	B1-U4-G3	5609	79.9	B3-U4-G2

Values from photometric tests performed in accordance with IESNA LM-79 and are representative of the configurations shown. Actual performance may vary due to installation and environmental variables, LED and driver tolerances, and field measurement considerations. It is highly recommended to confirm performance with a photometric layout.

NOTE: Some data may be scaled based on tests of similar (but not identical) luminaires. Contact factory for configurations not shown.



Miscellaneous

Description of Components:

Wiring: Gauge (#14) TEW/AWM 1015 or 1230 wires, 6" (152mm) minimum exceeding from luminaire.

Hardware: All exposed screws shall be complete with Ceramic primer-seal basecoat to reduce seizing of the parts and offers a high resistance to corrosion. All seals and sealing devices are made and/or lined with EPDM and/or silicone and/or rubber.

Finish: Color to be **bronze textured (BRTX)** and in accordance with the AAMA 2603 standard. Application of polyester powder coat paint (4 mils/100 microns) with ± 1 mils/24 microns of tolerance. The Thermosetting resins provides a discoloration resistant finish in accordance with the ASTM D2244 standard, as well as luster retention in keeping with the ASTM D523 standard and humidity proof in accordance with the ASTM D2247 standard.

The surface treatment achieves a minimum of 2000 hours for salt spray resistant finish in accordance with testing performed and per ASTM B117 standard.

Note: IMPORTANT: All missing details must be clearly specified on the return of these approval drawings. Thank you for your cooperation.

VOLTAGE: _____

LED products manufacturing standard: The electronic components sensitive to electrostatic discharge (ESD) such as light emitting diodes (LEDs) are assembled in compliance with IEC61340-5-1 and ANSI/ESD S20.20 standards so as to eliminate ESD events that could decrease the useful life of the product.

Quality Control: The manufacturer must provide a written confirmation of its ISO 9001-2008 and ISO 14001-2004 International Quality Standards Certification.

Web site information details: / [cULus Certification](#)

LED Wattage and Lumen Values: 4000K

Clear Globe

Ordering Code	Total LEDs	LED current (mA)	Average system watts (W)	RLE3			RLE5		
				delivered lumens	Efficacy (LPW)	BUG rating	delivered lumens	Efficacy (LPW)	BUG rating
40W42LED4K-G2-C	42	333	50	4830	96.2	B1-U3-G2	4845	96.5	B3-U3-G1
65W42LED4K-G2-C	42	500	70	6341	90.3	B2-U3-G2	6555	93.4	B3-U3-G2

Satin Clear Globe

Ordering Code	Total LEDs	LED current (mA)	Average system watts (W)	RLE3			RLE5		
				delivered lumens	Efficacy (LPW)	BUG rating	delivered lumens	Efficacy (LPW)	BUG rating
40W42LED4K-G2-CGB	42	333	50	4135	82.3	B1-U3-G2	4156	82.7	B2-U3-G2
65W42LED4K-G2-CGB	42	500	70	5348	76.2	B1-U4-G3	5609	79.9	B3-U4-G2

Values from photometric tests performed in accordance with IESNA LM-79 and are representative of the configurations shown. Actual performance may vary due to installation and environmental variables, LED and driver tolerances, and field measurement considerations. It is highly recommended to confirm performance with a photometric layout.

NOTE: Some data may be scaled based on tests of similar (but not identical) luminaires. Contact factory for configurations not shown.



E1.c.
SAMPLE PHOTOMETRICS SPACING OF 65 FT TYPE III – FOR PEDESTRIAN WALKWAYS,
BIKEWAYS, AND ROADWAYS
LED FIXTURE FOR NEW CONSTRUCTION (AS APPROVED)

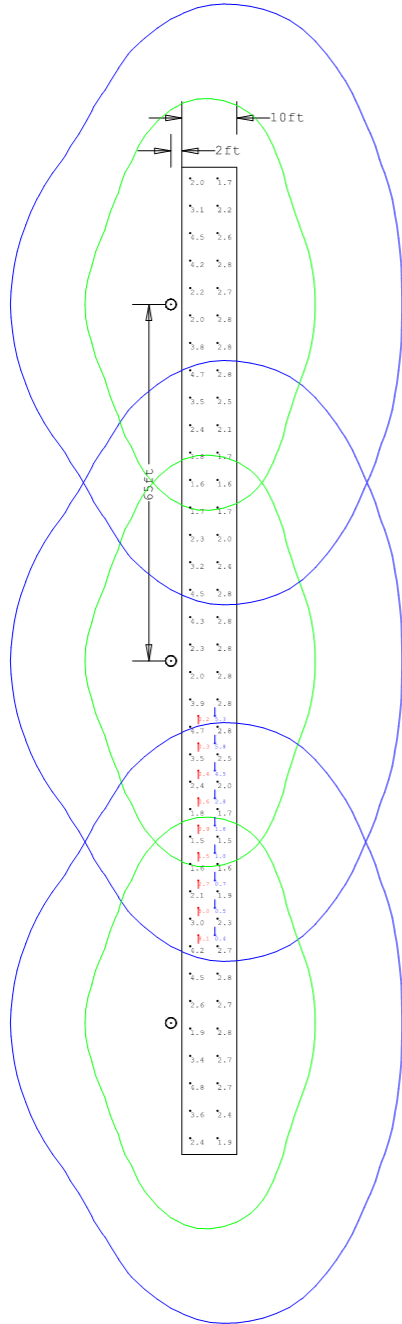

**NEW WEST MINISTER POST TOP
65W 4000K TYPE III**

VERTICAL CALC:
AVG: 2.19 FC
MAX: 8.1 FC
MIN: 0.2 FC

AVG/MIN: 10.95
MAX/MIN: 40.50

HORIZONTAL CALC:
AVG: 2.69 FC
MAX: 4.8 FC
MIN: 1.5 FC

AVG/MIN: 1.79
MAX/MIN: 3.20

ISOLINES AT 0.1 AND 0.5 FC



E1.c.

**SAMPLE PHOTOMETRICS SPACING OF 65 FT TYPE V – FOR PEDESTRIAN WALKWAYS AND BIKEWAYS
LED FIXTURE FOR NEW CONSTRUCTION (AS APPROVED)**

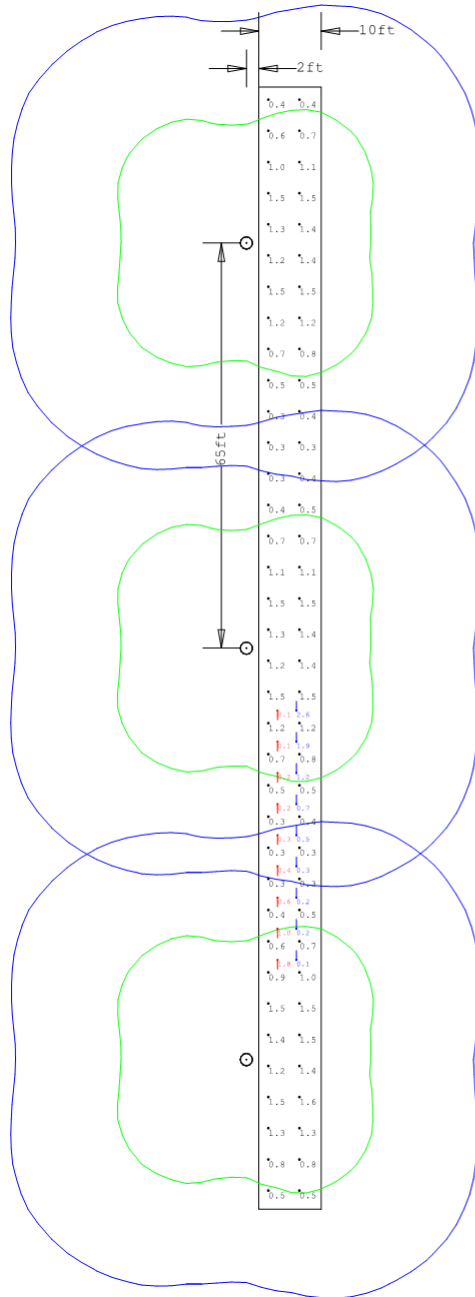

**NEW WEST MINISTER POST TOP
65W 4000K TYPE V**

**VERTICAL CALC:
AVG: 0.86 FC
MAX: 2.6 FC
MIN: 0.1 FC**

**AVG/MIN: 8.6
MAX/MIN: 26.0**

**HORIZONTAL CALC:
AVG: 0.92 FC
MAX: 1.6 FC
MIN: 0.3 FC**

**AVG/MIN: 3.07
MAX/MIN: 5.33**

ISOLINES AT 0.1 AND 0.5 FC



26 56 16
PARKING LIGHTING

1. GENERAL

A. Related sections:

- i. 26 56 00 – Exterior Lighting

B. Surface Parking Areas

- i. Illuminance levels for most campus parking lots are based on low-use criteria, while a few parking areas fall into the medium-use category. Uniformity and glare control are the most important factors in parking area lighting design because they contribute the most to nighttime visibility. These factors should take precedence over measured light levels. Vertical illumination is also important for motorists to be able to see pedestrians or obstructions such as curbs or poles; it is also critical for facial recognition and threat detection. Finally, care should be taken to avoid shadows and minimize light pollution and trespass.

- a. Pole mounted IESNA full-cutoff fixtures or cutoff fixtures with max 2% upward lumens will be used for parking lot lighting. Off-street parking and small parking lots may be lit using the standard decorative pole provided illuminance requirements listed below are met.
- b. All parking lots on campus shall be illuminated in the same way. Provide a maintained average illuminance of 2 footcandle over the parking surfaces, with a minimum level of 0.2 footcandle at the ground plane, a minimum vertical illuminance of 0.1 footcandle measured 5'-0" above the ground plane, and a maximum / minimum uniformity ratio of 20:1 (this means that if the minimum is 0.2 footcandle, the maximum footcandle level shall not be higher than 4.0 footcandles).
- c. These values are based on the Ninth Edition of the IES Handbook. Justification for exceeding the minimum standards shall be submitted to OUA during the design phase.

C. Parking Garages

- i. Parking deck lighting shall be designed with two key principles in mind. First, idle modes shall be implemented during off-peak hours to reduce light pollution and energy consumption. Second, light trespass from the parking aisles and entrances shall be strictly contained.
- ii. All parking garages on campus shall be illuminated in the same way. Refer to the following table for minimum illuminance values and uniformity ratios to be achieved:



Minimum Illuminance Values and Uniformity Ratios			
	Minimum Average Horizontal Footcandles	Maximum / Minimum Uniformity Ratio	Minimum Average Vertical Footcandles
Basic	1.0	10 : 1	0.5
Ramps (Day)	2.0	10 : 1	1.0
Ramps (Night)	1.0	10 : 1	0.5
Entrance (Day)	50.0 <i>Including Daylight Contribution</i>		25.0 <i>Including Daylight Contribution</i>
Entrance (Night)	1.0	10 : 1	0.5
Stairways (Non-Egress)	2.0		1.0
Lobbies	5.0	4 : 1	1.5

- a. Higher illuminance is necessary at the entrances during the daytime in order to provide a transition from the bright sunlit exterior into the comparatively low interior light level. The fixtures providing this additional light shall be circuited separately from the general lighting fixtures and placed on a timeclock to turn them off from dusk to dawn.
- b. If the garage has a top level that is open to sky, it shall have an maintained average illuminance level of at least 1 footcandle at the ground plane with a minimum maintained illuminance of 0.25 footcandle, and a minimum average vertical illuminance of 0.25 footcandle measured 5'-0" above the ground plane, and a maximum / minimum uniformity ratio of 15:1 (this means that if the minimum is 0.5 footcandle, the maximum level shall not be higher than 7.5 footcandles).
- c. Illuminance levels for parking decks are based on IESNA 9th edition handbook.
- d. Along with these requirements, the light exiting the parking garages needs to be controlled. In this effort, vertical illuminance levels on the perimeter wall surfaces facing into the garage shall not exceed 1 footcandle maintained at any point.
- e. Lighting in garages containing CCTV cameras shall be coordinated with the security consultant. Depending on the model of camera used, a certain minimum vertical illuminance will need to be provided to properly allow the cameras to capture video.
- f. Light fixtures with atmospheric backgrounds shall be white in color so as to blend in. As an example, light poles mounted on top of parking decks shall be white.
- g. All new and renovated parking garages shall employ LED lighting with the following features and controls incorporated in conjunction with a dedicated lighting relay panel (Wattstopper or similar):



- 1) Daylight sensors and daylight responsive switching / dimming along perimeter of the garage, as determined by the lighting designer.
- 2) The parking garage will be divided into zones based on circulation and occupancy patterns, and lighting at each zone will be controlled by astronomical timeclock and ceiling mounted occupancy / vacancy sensors strategically located to cover the zone. Timeclock will control the zones during the peak hours of the buildings, and the sensors will take over during off-peak hours. The sensors will be set to an adequate delay to prevent frequent switching cycles.
- 3) Sensors mounted to each fixture are not recommended, and will be reviewed on a case by case basis.
- 4) Commissioning and programming of the systems shall be included in base bids of the projects.

2. PRODUCTS

- A. For Parking Lighting – Series E1
- B. See following product cut sheets for additional specification information on Series E1:
 - E3.a. Parking Surface Fixture – LED
 - E3.b. Pole for E3.a
 - E3.c. Bracket options for E3.a.



E3.a.
FOR PARKING SURFACES
PARKING SURFACE FIXTURE – LED

A. Specification

- i. LED replacement for conventional source full-cutoff fixtures, equal to Philips Lumec RoadStar, 4000K CCT with ≥ 70 CR, available in IESNA Type II, III, IV, and V distributions, black powdercoat finish (or white, on top of parking deck).
- ii. Mountings shall be equal to Philips Lumec PC4, 6, OR 8, or PSA4.

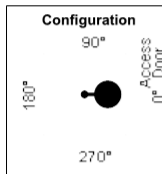
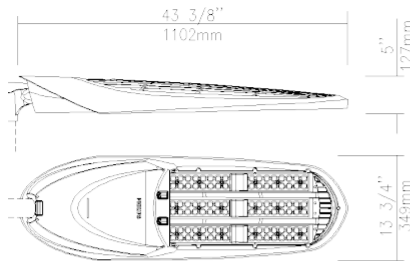

EPA: 0.94 sq ft / weight: 27 lb (12.3 kg)
Note: 3D image may not represent color or option selected.
Logos above include link, click to access.



Description of Components:

Housing: The upper grid and lower part of the housing are made of a low copper die cast Aluminum alloy (A360), 0.100" (2.5mm) minimum thickness. Fits on a 1.66" (42mm) O.D. (1.25" NPS), 1.9" (48mm) O.D. (1.5" NPS) or 2 3/8" (60mm) O.D. (2" NPS) by 7 3/4" (197mm) minimum long tenon. Comes with two zinc plated clamps fixed by 4 zinc plated hexagonal bolts 3/8 16 UNC for ease of installation. Provides an easy step adjustment of +/- 5° tilt in 2.5° increments. A quick release removable door opens downward to provide access to electronic components and to a terminal block. Door is secured to prevent accidental dropping or disengagement. Complete with a bird guard protecting against birds and similar intruders.

Light Engine: Composed of 4 main components: **Heat Sink / LED Module / Optical System / Driver**
Electrical components are RoHS compliant, IP66 sealed light engine. Metal core board ensures greater heat transfer and longer lifespan.

Heat Sink: Built in the housing, designed to ensure high efficacy and superior cooling by natural convection air flow pattern always close to LEDs and driver optimising their efficiency and life. Entire luminaire is rated for operation in ambient temperature of -40°C / -40°F up to +40°C / +104°F.

LED Module: Composed of 80 high-performance white LEDs. Color temperature as per ANSI/NEMA bin Neutral White, 4000 Kelvin nominal (3985K +/- 275K or 3710K to 4260K), CRI 70 Min. 75 Typical.

Optical System: (DIST), IES type II, III, IV, or V. Distribution type to be coordinated per project design requirements with SESCO Lighting, Contact Thomas Nichols (tnichols@SESCOlighting.com). System is rated IP66. Performance shall be tested per LM-63, LM-79 and TM-15 (IESNA) certifying its photometric performance.0% uplight and U0 per IESNA TM-15.

Driver: High power factor of 90% minimum. Electronic driver, operating range 50/60 Hz. Auto-adjusting universal voltage input from 120 to 277 VAC rated for both application line to line or line to neutral, Class 1, THD of 20% max. **Driver comes with dimming compatible 0-10 volts.**



Luminaire Options: (RCD7), Receptacle with 7 pins enabling dimming and with two extra connections for future use (these connections are capped off at the factory - requires connections to be made in the field), can be used with a twist-lock control device or photoelectric cell or a shorting cap. Use of photocell or shorting cap is required to ensure proper illumination. (SP2), Integral surge protector tested in accordance with ANSI/IEEE C62.45 per ANSI/IEEE C62.41.2 Scenario I Category C High Exposure with elevated 20kV/10kA waveforms for Line-Ground, Line-Neutral and Neutral-Ground.

Finish: Color to be black or white (BK or WH) and in accordance with the AAMA 2603 standard. Application of polyester powder coat paint (4 mils/100 microns) with ± 1 mils/24 microns of tolerance.

LED light engine technical information for GPLM											
CRI = 70, CCT = 4000K (3985K +/- 275K or 3710K to 4260K)											
System (LED + driver) rated life = 100,000 hrs ¹ / 93,000 hrs ²											
LED Module	Typical delivered lumens	Typical system wattage ³ (W)	Typical current @ 120 V (A)	Typical current @ 208 V (A)	Typical current @ 240 V (A)	Typical current @ 277 V (A)	Typical current @ 347 V (A)	Typical current @ 480 V (A)	LED current (mA)	Luminaire Efficacy Rating (lm/W)	BUG rating
80L1050NW-G2-R3S	26137	270	2.22	1.27	1.11	0.96	0.78	0.57	1050	97	B3-U0-G4
80L1050NW-G2-R3W	26038	270	2.22	1.27	1.11	0.96	0.78	0.57	1050	96	B3-U0-G4
80L1050NW-G2-4	26105	270	2.22	1.27	1.11	0.96	0.78	0.57	1050	97	B3-U0-G4
80L1050NW-G2-5	27136	270	2.22	1.27	1.11	0.96	0.78	0.57	1050	101	B5-U0-G3
96L530NW-G2-R2M	18580	158	1.32	0.78	0.7	0.62	0.47	0.35	530	118	B3-U0-G3
96L530NW-G2-R2S	19564	158	1.32	0.78	0.7	0.62	0.47	0.35	530	124	B3-U0-G2
96L530NW-G2-R3M	17872	158	1.32	0.78	0.7	0.62	0.47	0.35	530	113	B3-U0-G3
96L530NW-G2-R3S	18532	158	1.32	0.78	0.7	0.62	0.47	0.35	530	117	B2-U0-G3
96L530NW-G2-R3W	18263	158	1.32	0.78	0.7	0.62	0.47	0.35	530	116	B3-U0-G3
96L530NW-G2-4	18419	158	1.32	0.78	0.7	0.62	0.47	0.35	530	117	B3-U0-G3
96L530NW-G2-5	19121	158	1.32	0.78	0.7	0.62	0.47	0.35	530	121	B4-U0-G2
96L700NW-G2-R2M	23082	213	1.74	1.01	0.89	0.80	0.62	0.45	700	109	B3-U0-G3
96L700NW-G2-R2S	24304	213	1.74	1.01	0.89	0.80	0.62	0.45	700	114	B3-U0-G2
96L700NW-G2-R3M	23121	213	1.74	1.01	0.89	0.80	0.62	0.45	700	108	B3-U0-G3
96L700NW-G2-R3S	23022	212	1.74	1.01	0.89	0.80	0.62	0.45	700	109	B3-U0-G4
96L700NW-G2-R3W	22688	214	1.74	1.01	0.89	0.80	0.62	0.45	700	106	B3-U0-G4
96L700NW-G2-4	22882	213	1.74	1.01	0.89	0.80	0.62	0.45	700	107	B3-U0-G4
96L700NW-G2-5	23753	213	1.74	1.01	0.89	0.80	0.62	0.45	700	112	B5-U0-G3
96L1050NW-G2-R2M	30975	320	2.66	1.52	1.33	1.15	0.93	0.68	1050	97	B4-U0-G4
96L1050NW-G2-R2S	32924	324	2.66	1.52	1.33	1.15	0.93	0.68	1050	102	B4-U0-G3
96L1050NW-G2-R3M	31496	325	2.66	1.52	1.33	1.15	0.93	0.68	1050	97	B4-U0-G4
96L1050NW-G2-R3S	30629	321	2.66	1.52	1.33	1.15	0.93	0.68	1050	95	B3-U0-G4
96L1050NW-G2-R3W	30519	326	2.66	1.52	1.33	1.15	0.93	0.68	1050	94	B3-U0-G5
96L1050NW-G2-4	30598	326	2.66	1.52	1.33	1.15	0.93	0.68	1050	94	B3-U0-G5
96L1050NW-G2-5	31797	323	2.66	1.52	1.33	1.15	0.93	0.68	1050	98	B5-U0-G4

1 L70 = 100,000 hrs [at ambient temperature = 25°C and forward current = 350 to 700 mA] 2 L70 = 93,000 hrs [at ambient temperature = 25°C and forward current = 1050 mA]

3 System wattage or total luminaire wattage includes the LED module and the LED driver.

Note that IES files with HS house side shield option are also available – contact the factory.

Note : Due to rapid and continuous advances in LED technology, LED luminaire data is subject to change without notice and at the discretion of Philips.



E3.b.
FOR PARKING SURFACES
POLE FOR FIXTURES E3.a.

A. Specification

- i. Equal to Philips LUMEC ATR64N round tapered Aluminum, Height to be 25', unless otherwise approved by Project Manager. Finish to be Black (or white, on top of parking deck). Wall thickness to be confirmed by a structural engineer. Round Tapered Steel version accepted on top of parking garages and on any Bridge or Overpass.

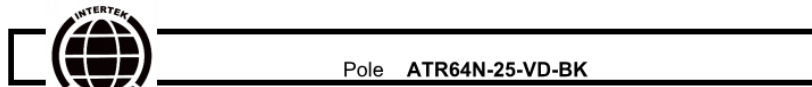
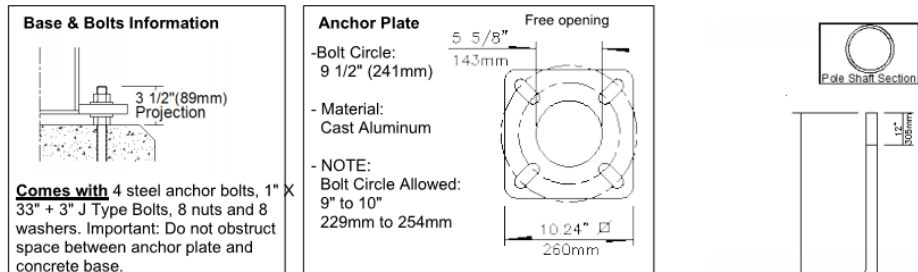

Description of Components:

Pole Shaft: Shall be made from spun aluminum 6063-T4, tempered to T6 after welding, having a base diameter of 6" (152mm) and top diameter of 4" (102mm) wall thickness 0.188" (4.8mm) welded to both the bottom and top of the anchor plate.

Maintenance Opening: The pole shall have a 3" x 5" (76mm x 127mm) maintenance opening centered 20" (508mm) from the bottom of the anchor plate, complete with a weatherproof aluminum cover and a copper ground lug.

Anchor Bolts: Anchor bolts made of ASTM F1554 grade 55 steel having a minimum yield strength of 55000 psi. Nuts made of ASTM A563 grade A steel or better. The thread fit is ANSI class 2B regardless of bolt diameter. Washers are made of ASTM grade F-844 or better steel. All galvanized parts are hot dip galvanized per ACNOR G-164 minimum.

Nut cover: Made from cast 356 aluminum, mechanically fastened with stainless steel screws.

Hardware: All exposed screws shall be complete with Ceramic primer-seal basecoat to reduce seizing of the parts and offers a high resistance to corrosion. All seals and sealing devices are made and/or lined with EPDM and/or silicone and/or rubber.

Pole Options: (VD) Complete with an internal vibration damper.

Pole Weight: 82 lbs (37.3 kg)

IMPORTANT: Lumec strongly recommends the installation of the complete lighting assembly with all of its accessories upon the anchoring of the pole. This will ensure that the structural integrity of the product is maintained throughout its lifetime.

Aluminum poles are not recommended in high vibration environments such as bridge, overpass, top of building, airport, train station, etc.

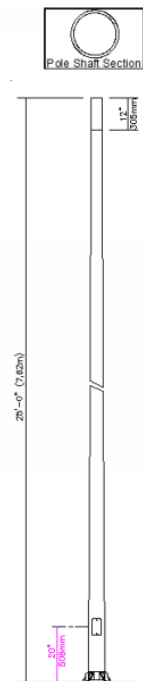



E3.c.
FOR PARKING SURFACES
BRACKET OPTIONS FOR FIXTURE E3.a

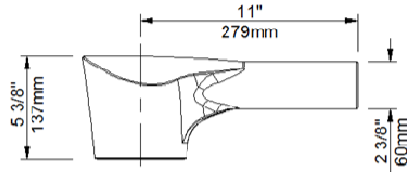

PSA4

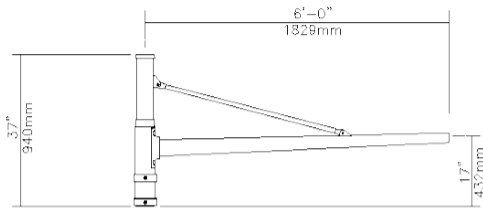

PC4, 6, or 8

PSA4-1A-BK/WH

PC4/6/8-1A-R4-BK/WH

Description of Components:

Arm: Made of cast 356 aluminum. Slip-fits over a 4" (102mm) outside diameter pole or tenon. Mechanically fastened to the pole or tenon.

Hardware: All exposed screws shall be complete with Ceramic primer-seal basecoat to reduce seizing of the parts and offers a high resistance to corrosion. All seals and sealing devices are made and/or lined with EPDM and/or silicone and/or rubber.

Finish: Color to be black or white (**BK or WH**) and in accordance with the AAMA 2603 standard. Application of polyester powder coat paint (4 mils/100 microns) with ± 1 mils/24 microns of tolerance.

PSA4 Bracket Properties (Weight and EPA): 3 lbs (1.4 kg), .33 ft²

PC6 Bracket Properties (Weight and EPA): 28 lbs (12.7 kg), 3.64 ft²



E4.a.
FOR PARKING GARAGES
GLOBE SHAPED – LED

- A. HID Fixture Specification
- i. Equal to KIM Lighting PGL7-LED fixture, 65W or 84W (as required), 4200K CCT with ≥ 70 CRI, standard UV stabilized acrylic refractor lens, tamper resistant latches, integral fusing (1 for 1-pole / 2 for 2-pole circuits), -20 °F to 104 °F & IP65/IP66 rated, and standard white powdercoat finish.



KIM LIGHTING

PGL7 LED
LED Parking Garage Luminaire
revision 11/23/16 • kd_pgl7led_spec.pdf

Type:
Job:



Approvals:

Fixture Catalog number:

Fixture	Current	Electrical Module	Optional Features
	/	/	/
	See page 2	See page 2	See page 3-4

Date:
Page: 1 of 6

Specifications

PGL7-LED

60 Light Emitting Diodes
65 System Watts for 350mA
84 System Watts for 480mA
Maximum Weight = 19 lbs

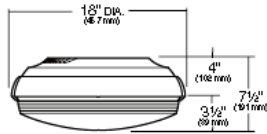

Fixture with Standard Acrylic Refractor

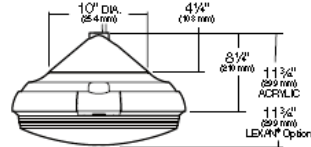

Fixture with Optional Balanced Pendant
J-Box and Bird Shroud (PB2)

Speed Mount: Electro-zinc plated steel for mounting to standard 4" junction box or mud-box. Fixture hangs from hooks to free both hands to make field wire connection. Allows tool-free fixture mounting to junction box, with integral anti-theft lock.

Electrical Housing: Die-cast, low copper (<0.6% Cu) aluminum alloy for direct mounting to the Kim Speed Mount. Wire entries are sealed by a silicone grommet.

Refractor: Standard refractor is one-piece injection molded acrylic, .125" minimum wall thickness. The prisms around the perimeter reflect the up light off each PicoEmitter™ upward to eliminate the cave effect. Refractor attaches to electrical housing with (2) load bearing retainers. Perimeter is fully sealed with a one-piece extruded silicone gasket, with the ends fused together to form a continuous piece, sealing the refractor to the electrical housing, and providing an IP66 fixture rating.

EmitterDeck®: Precision injection molded optics are positioned to achieve directional control toward desired task. The entire assembly fastens to the housing as a one-piece module.

Electronic Module: All electrical components are UL recognized and mounted directly to the electrical housing for maximum heat dissipation. Module includes a driver, thermal control device and surge protector. Driver is rated for -40°C operation. A step-down transformer within the housing may be used for 347V and 480V systems. All luminaires include an internal fuse.

Finish: Standard finish on fixture electrical housing, optional PB2 and TB2, is (PS) Platinum Silver. Platinum Silver is Powder® TGIC powder coat paint.

Listed to: UL 1598 Standard for Luminaires - UL 8750 Standard for Safety for Light Emitting Diode (LED) Equipment for use in Lighting Products and CSA C22.2#250.0 Luminaires.

Warranty: Kim Lighting warrants PGL7 LED products ("Product(s)") sold by Kim Lighting to be free from defects in material and workmanship for (i) a period of five (5) years for metal parts, (ii) a period of ten (10) years for exterior housing paint finish (i) a period of six (6) years for LED Light Engines (PicoEmitters) and, (iv) a period of five (5) years for LED power components (LED Driver, LifeShield® device, Surge Protector) from the date of sale of such goods to the buyer as specified in Kim Lighting shipment documents for each product.

CAUTION: Fixtures must be grounded in accordance with national, state and/or local electrical codes. Failure to do so may result in serious personal injury.



Patent Pending

KIM LIGHTING RESERVES THE RIGHT TO CHANGE SPECIFICATIONS WITHOUT NOTICE.



E4.b.
FOR PARKING GARAGES
LINEAR FIXTURE – LED

A. Fluorescent Fixture Specification

- i. Equal to Lithonia Lighting wet location, vandal resistant VAP LED fixture, clear polycarbonate lens, 4000K CCT with ≥ 70 CRI, integral fusing (1 for 1-pole / 2 for 2-pole), tamper-resistant and tool free stainless steel latches, standard white powdercoat finish, -20 °F to 104 °F & IP65/IP66 rated.



FEATURES & SPECIFICATIONS

INTENDED USE — Ideal for use in applications where smart, energy-efficient fixtures are desired. Typical applications include parking garages, canopies, transportation, schools, hospitals, cold storage and exterior retail environments where moisture or dust is a concern. Polycarbonate enclosure protects fixture while remaining easy to service and clean. Certain airborne contaminants can diminish the integrity of acrylic and/or polycarbonate. [Click here for Acrylic/Polycarbonate Compatibility table for suitable uses.](#)

CONSTRUCTION — UV-stabilized, injection-molded, impact-resistant, frosted polycarbonate housing with continuous poured-in-place, closed-cell gasket, 20-gauge steel channel and channel cover. Aluminum sheet metal board plate for thermal conduction and support. Capive, tamper-resistant, polycarbonate latches standard (8 Torx T-20 tamper-resistant screws included). Stainless steel latches also available. Fixture design allows for approximately 48% up-light.

OPTICS — UV-stabilized, injection-molded, impact-resistant, clear transparent and frosted, polycarbonate lens with aesthetic rib detail (.080" thick). Mirror aluminum reflector used to achieve wide distribution.

ELECTRICAL — Utilizes high-output LEDs integrated on a two-layer circuit board, ensuring cool-running operation. Electronic LED driver rated for 48 input watts and is standard 0-10V dimming. Integral 6kV/3kA surge protection, tested in accordance to IEEE/MNS standards. L85 at 60,000 hours.

INSTALLATION — Stainless steel surface spring-mounting brackets standard (2 included) allows for ceiling or suspended mount. A variety of stainless steel mounting options also available. Box mounting and mounting brackets for suspension with aircraft cable (cable not included). Optional stainless steel V-hooks available for chain hanging (chain not included). Surface conduit entry on each end and on top. For horizontal and vertical mounting on a wall, application must be under a covered ceiling and QMB option recommended. 1/2" - 3/4" KO. When wall mounted, the product will be rated for damp location only.

LISTINGS — CSA Certified to UL and C-UL standards. For use in ambient temperatures ranging from -20°F (-29°C) to 104°F (40°C). VAP LED is wet location listed for covered ceiling applications. IP65 and IP66 rated. VAP LED is NSF Splash Zone rated when suspended or ceiling mounted. When wall mounted the product will be rated for damp location only. DesignLight Consortium[®] (DLC) qualified product. Not all versions of this product may be DLC qualified. Please check the DLC Qualified Products List at www.designlights.org to confirm which versions are qualified.

WARRANTY — 5-year limited warranty. Complete warranty terms located at www.aclbrands.com/CustomerResources/Terms_and_conditions.aspx

For installed Rough Service Product(s), Acuity warrants that for the lifetime of the product(s), the polycarbonate lens and/or polycarbonate housing will withstand breakage resulting from occasional physical abuse and rough handling (the "Rough Service Warranty"), notwithstanding the vandalism exclusion set forth at www.aclbrands.com/CustomerResources/Terms_and_conditions.aspx

Note: Actual performance may differ as a result of end-user environment and application. All values are design or typical values, measured under laboratory conditions at 25 °C.

Specifications subject to change without notice.

Catalog Number	
Notes	
Type	



Specifications

Length: 54-3/4" (139.1)
Width: 8-1/4" (21.0)
Depth: 4-1/8" (10.5)
Weight: 13.5 lbs. (5.9 kg)

All dimensions are shown in inches (centimeters) unless otherwise noted.

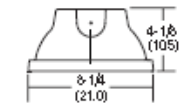



E4.c.
FOR PARKING GARAGES
LED RETROFIT FOR FIXTURE E4.b.

A. LED Lamp Specification

- i. Equal to Bartco LED tube made of extruded aluminum / heat sink, extruded linear ribbed lens to hide direct view of emitters, 350mA driving current, installs in fluorescent sockets after bypass of fluorescent ballast, 4000K CCT with >/= 80CRI. Mock-up strongly recommended before permanent installations.



Eco 8

type:

Eco 8 LED

linear LED line voltage lamp

- PERFORMANCE**
- LED tubes are arranged in standard linear T8 fluorescent sizes
 - Components can install as direct replacements for linear fluorescent lamp
 - Construction: extruded aluminum body/heat sink
 - LED lumen output: 100 Lumens/350 mA
 - LED beam spread: 115°
 - Linear lamp operating temperature: 50°C @ 25°C ambient
 - Listing: ETL
 - Base - medium Bi Pin

- POWER SUPPLY**
- Direct line voltage (120v) componentry, does NOT need an external driver
 - Operating voltage 120V
 - Output current 160mA

Can be used with a variety of Bartco luminaires

*Fixture Sold Separately

PROFILE

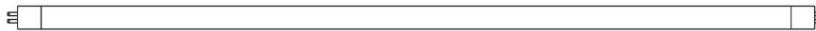
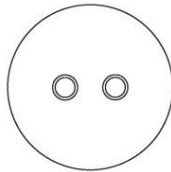

SPECIFICATION / ORDER FORMAT			DIMENSIONAL INFO.		
model no.	nominal length	wattage	color temp.	(kelvin)	lumens
Eco 8	2' Bi Pin - 23.2"	8W	/WW - Warm White	(3,000 +/- 500°)	550
	3' Bi Pin - 35.2"	12W	/NW - Neutral White	(4,000 +/- 500°)	1100
	4' Bi Pin - 47.2"	16W			850
specification order					
example: Eco 8-4/ww					

LED
architectural LIGHTING

01.2011



E4.d.
FOR PARKING GARAGES
VARIOUS SHAPES INTEGRAL LED

A. LED Fixture Specification

- i. Equal to Philips WideLite extruded aluminum construction with die-cast end caps, faceted reflector optics for indirect lighting with no view of LEDs, 350-700mA driving current, 4100K CCT with >= 70 CRI, integral dimming/occupancy sensor options.

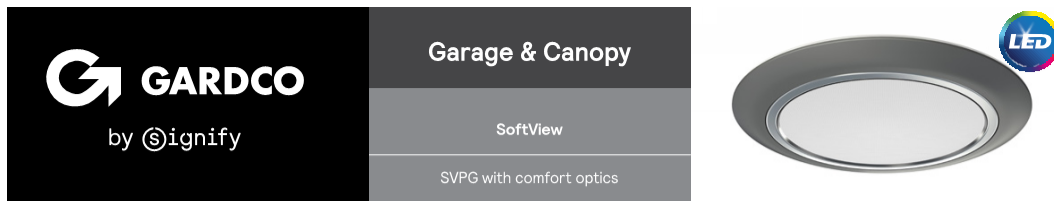

Gardco SoftView LED parking garage luminaires feature edge lit technology, providing visual comfort with minimal glare to enhance the user experience. An added uplight feature reduces the cave effect for an increased sense of security. SoftView features multiple optical distributions, lumen packages and mounting options providing you with the ideal solution for your garage lighting needs. Optional emergency battery backup available for path of egress lighting and is integral to the luminaire.

Project: _____
 Location: _____
 Cat.No: _____
 Type: _____
 Lamps: _____ Qty: _____
 Notes: _____

Ordering guide

example SVPG-140L-2100-NW-G2-SM-5-BL-IMR12-MGY

Luminaire	Number of LEDs	Drive Current	Color Temperature	Mounting	Distribution	Emergency	Voltage	Options				
								Dimming controls	Motion sensing	Electrical	Finish	
SVPG	140L											
SVPG SoftView Parking Garage	140 LEDs (comfort engine)	450 450mA 800 800mA 1200 1200mA 1675 1675mA 2100 2100mA	WW-G2 Warm White 3000K (70 CRI) Generation 2 NW-G2 Neutral White 4000K (70 CRI) Generation 2 CW-G2 Cool White 5000K (70 CRI) Generation 2 WY-G2 Warm Yellow 2700K (80 CRI) Generation 2 ¹ BW-G2 Balanced White 3500K (80 CRI) Generation 2 ¹	SM Surface / Pendant Mount (pendant and junction box by others) T¹⁵ Trunnion Mount (ordered separately, see Accessories) WM Wall Mount (ordered separately, see Accessories)	IR Type IR Rectangular 3¹ Type III Asymmetric S Type V CD Concentrated Downlight	NONE Leave Blank EBP ^{12,17} Emergency Battery pack EBPC ^{14,15} Emergency Battery pack cold rated UNV Universal 120-277V 347 347V 480 480V HVU Universal 347-480V	120 120V 208 208V 240 240V 277 277V UNV Universal 120-277V 347 347V 480 480V HVU Universal 347-480V	NONE Leave Blank DD ^{13,14} 0-10V Dimming external leads (controls by others) BL ^{16,18} Bi-level with motion sensor LLC ^{19,20} Wireless Controls	NONE Leave Blank IMR12 ² Integral Motion Response: #2 lens IMR3 ³ Integral Motion Response: #3 lens <i>(factory customizable, contact factory³)</i>	Fusing F1 ¹ Single Fuse (120, 277, 347V) F2 ² Double Fuse (208, 240, 480V) F3 ³ Double Fuse Canadian double pull (208, 240, 480V) Surge Protection blank SPI 10KV SKA (standard) SP2 20KV 10KA (option)	BZ Bronze MGY Medium Gray WH White OC Optional Color Specify optional color or RAL ex. OC-LGP or OC-RAL7024 SC Special Color Must supply color chip Requires factory quote.	

1. Choose either **EBP** suitable for 0°C (32°F) to +40°C (+104°F) or **EBPC** suitable for -20°C (-4°F) to +40°C (+104°F).
2. Not available with **347V, 480V** or **HVU**.
3. Not available with 1200mA, 1675mA or 2100mA.
4. Not available with 2100mA.
5. Extended lead times apply. Contact factory for details.
6. Not available with Emergency options (**EBP, EBPC**).
7. Available with **120V, 208V, 240V, 277V** or **UNV** only.
8. Provide specific input voltage.
9. Luminaire includes 0-10V dimming wires for dimming control by others.
10. 0-10V dimming driver standard.
11. Must be combined with Motion Sensing option (**IMR12** or **IMR13**).
12. Must be combined with Dimming Controls option (**BL** or **LLC**).
13. Not available with Motion Sensing.
14. Not available with other Dimming Controls.
15. Trunnion Mount (**T**) not available with both **DD** and **EBP** or **EBPC**; is available with each individually (**DD** or **EBP** or **EBPC**).



SVPG SoftView LED

Garage & Canopy – Parking Garage Luminaires

Accessories (ordered separately)

FSIR-100 Hand-held programmer (For use with 'IMRI2' and 'IMRI3' motion response when field programming is required) If desired, only one is needed per job.	SVPG-G2-TM-(F) Trunnion Mount kit (field installed)	BXC Bird excluding coil (field installed, fits on all mounting options)
ES External House Side Shield (field installed)	SVPG-G2-WM-(F) Wall Mount (field installed)	BXK Bird excluding spikes (field installed, fits on Pendant, Trunnion, and Wall mounts only)
	(F) = specify finish	BXS Bird excluding shroud (field installed, fits on Pendant mount only)

LED wattage and lumen values

Ordering Code	Total LEDs	LED Current (mA)	Color Temp.	Average System Watts	Type 1R		Type 3		Type 5		Type CD	
					Lumen Output	Efficacy (LPW)	Lumen Output	Efficacy (LPW)	Lumen Output	Efficacy (LPW)	Lumen Output	Efficacy (LPW)
SVPG-140L-450-NW-G2-x	140	450	4000K	22	2,223	101	2,366	107	2,395	108	2,522	114
SVPG-140L-800-NW-G2-x	140	800	4000K	37	3,854	105	4,103	111	4,153	113	4,374	119
SVPG-140L-1200-NW-G2-x	140	1200	4000K	54	5,563	103	5,921	110	5,994	111	6,312	117
SVPG-140L-1675-NW-G2-x	140	1675	4000K	76	7,484	99	7,967	106	8,065	107	8,494	112
SVPG-140L-2100-NW-G2-x	140	2100	4000K	95	8,960	95	9,538	101	9,655	102	10,168	107
SVPG-140L-450-WW-G2-x	140	450	3000K	22	2,146	97	2,285	103	2,313	105	2,436	110
SVPG-140L-800-WW-G2-x	140	800	3000K	37	3,722	101	3,962	108	4,010	109	4,223	115
SVPG-140L-1200-WW-G2-x	140	1200	3000K	54	5,371	100	5,718	106	5,788	107	6,095	113
SVPG-140L-1675-WW-G2-x	140	1675	3000K	76	7,227	96	7,693	102	7,788	103	8,202	109
SVPG-140L-2100-WW-G2-x	140	2100	3000K	95	8,652	91	9,210	97	9,323	98	9,818	104
SVPG-140L-450-CW-G2-x	140	450	5000K	22	2,324	105	2,474	112	2,505	113	2,638	119
SVPG-140L-800-CW-G2-x	140	800	5000K	37	4,031	110	4,291	117	4,343	118	4,574	124
SVPG-140L-1200-CW-G2-x	140	1200	5000K	54	5,817	108	6,193	115	6,269	116	6,602	122
SVPG-140L-1675-CW-G2-x	140	1675	5000K	76	7,827	104	8,332	110	8,434	112	8,883	118
SVPG-140L-2100-CW-G2-x	140	2100	5000K	95	9,370	99	9,975	105	10,097	107	10,634	112

Emergency mode:

Ordering Code	Lumen output	Maximum mounting height
SVPG-140L-xxx-NW-G2-5-EBP	1696	14.8 ft
SVPG-140L-xxx-NW-G2-5-EBPC	2293	16.7 ft

Values from photometric tests performed in accordance with IESNA LM-79 and are representative of the configurations shown. Actual performance may vary due to installation and environmental variables, LED and driver tolerances, and field measurement considerations. It is highly recommended to confirm performance with a photometric layout.

NOTE: Some data may be scaled based on tests of similar (but not identical) luminaires. Contact factory for configurations not shown.

For emergency **EBP** and **EBPC** options, published values are based on initial lumens. It is highly recommended to confirm with a photometric layout that emergency performance meets your applicable ordinances.



SVPG SoftView LED

Garage & Canopy - Parking Garage Luminaires

Dimension drawings

Surface / Pendant mount

Top view

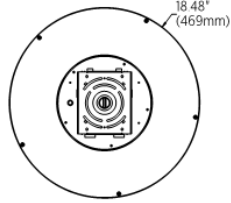

Side view

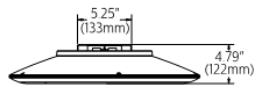

SoftView LED	Weight
Luminaire	8.2 lbs (3.7 Kg)
Luminaire with EBP	10.7 lbs (4.9 Kg)
Luminaire with EBPC	14.2 lbs (6.4 Kg)

Trunnion mount

Top view

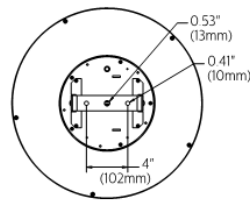

Side view

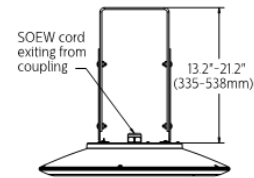

Wall mount

Top view

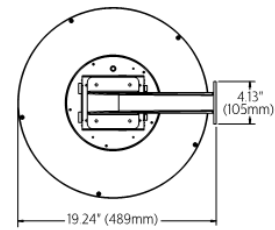

Side view



Front view

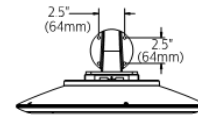

Motion response and wireless controls

Bottom view

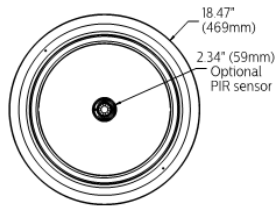

Side view

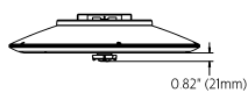

External house side shield

Bottom view

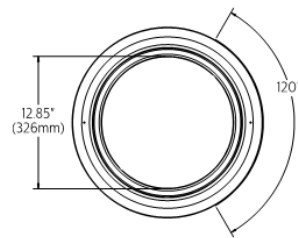

Side view

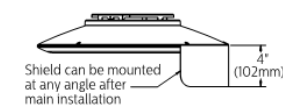

BXS Bird excluding shroud

Top view

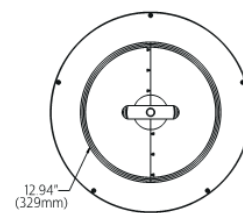

Side view

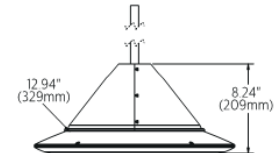



SVPG SoftView LED

Garage & Canopy - Parking Garage Luminaires

Programmable motion response

SoftView luminaires with Programmable Motion Response (IMRI2 or IMRI3) include a passive infrared (PIR) motion sensor (WattStopper FSP-211 or FSP-221B) available with two different sensor lens types to accommodate various mounting heights and occupancy detection ranges (see charts below for approximate detection patterns). The PIR sensor is factory installed and integral to the luminaire as indicated in drawings on page 3. Motion sensor standby power is 0.5 watts.

Programmable Motion Response (IMRI2 or IMRI3) luminaires are programmed at the factory as follows: when no motion is detected for 10 minutes, the Motion Response system reduces the wattage by 80%, to 20% (per RP-20) of the normal constant wattage, reducing the light level accordingly. When motion is detected by the PIR, the luminaire returns to full wattage and full light output. Dimming on low is factory set to 80% with duration set at 10 minutes. Factory customizable luminaires are programmed at the factory per your custom requirements. Both IMRI2 and IMRI3 include a daylight sensor which enables daylight harvesting ; product ships with daylight harvesting disabled - enable in the field using FSIR-100 programming tool.

The approximate motion sensor coverage pattern is as shown below.

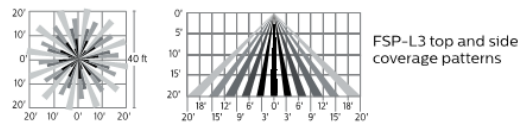
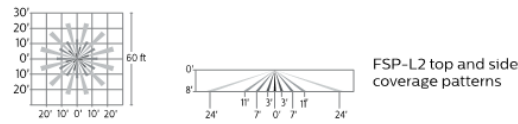

FSIR-100 Wireless Remote Programming Tool

If you want to change the factory programming, the FSIR-100 Wireless Remote Programming Tool accessory enables on-site field adjustment of sensor settings, including duration and dimming level on low, without the need to connect any wires to the luminaire.

The FSIR-100 is a handheld tool that provides wireless access to the FSP-211 sensors for setup, testing and parameter changes.

The FSIR-100 display shows menus and prompts to lead you through each process. The navigation pad provides a familiar way to navigate through the customization fields.

Within 8-12' mounting height of the sensor, the FSIR-100 allows modification of the system without requiring ladders or tools simply with a touch of a few buttons.

The FSIR-100 IR transceiver allows bi-directional communication between the FSP-211 and the FSIR-100 programming tool. Simple menu screens let you see the current status of the system and make changes. It can change FSP-211 sensor parameters such as high/low mode, sensitivity, time delay, cut off and more. With the FSIR-100 you can also establish and store FSP-211 parameter profiles.

The FSIR-100 operates on three standard 1.5V AAA Alkaline batteries or three rechargeable AAA NIMH batteries. The battery status displays in the upper right corner of the display. Three bars next to BAT= indicates a full battery charge. A warning appears on the display when the battery level falls below a minimum acceptable level. To conserve battery power, the FSIR-100 automatically shuts off 10 minutes after the last key press.



You navigate from one field to another using (up) or (down) arrow keys. The active field is indicated by flashing (alternates between yellow text on black background and black text on yellow background.)

Once active, use the Select button to move to a menu or function within the active field. Value fields are used to adjust parameter settings. They are shown in "less-than/greater-than" symbols: <value>. Once active, change them using (left) and (right) arrow keys. In general the up key increments and the down key decrements a value. Selections wrap-around if you continue to press the key beyond maximum or minimum values. Moving away from the value field overwrites the original value. The Home button takes you to the main menu. The Back button can be thought of as an undo function. It takes you back one screen. Changes that were in process prior to pressing the key are lost.

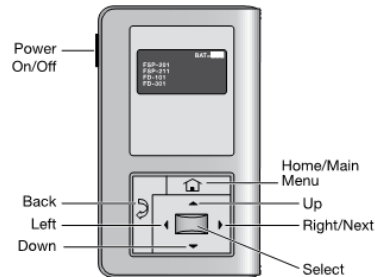

More information on the FSIR-100 Remote Programming Tool is available at wattstopper.com.



SVPG SoftView LED

Garage & Canopy – Parking Garage Luminaires

Radio and motion sensor details

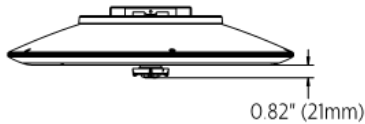

- Motion sensor coverage can be adjusted from a narrow to a wide (25' radius) detection range, which helps reduce false triggers to further increase energy savings.
- 1.8 Watts max (no load draw)
- Operating voltage 120-277 VAC RMS
- Communicates using the ZigBee protocol
- Carries out dimming commands from Gateway
- Reports ambient light readings to 1500 Ft-Cd
- Transmission Systems Operating within the band 2400-2483.5Mhz
- ROHS Compliant
- Sensing profiles can be updated to adapt to activity levels in the environment, such as occupancy level, wind, and mounting height.

Typical Sensor Coverage

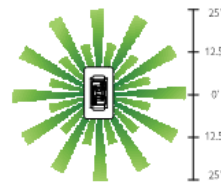
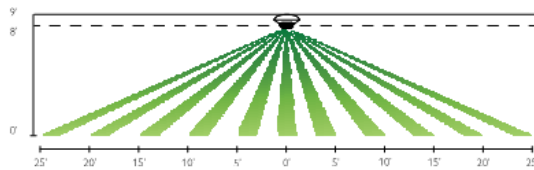



SVPG SoftView LED

Garage & Canopy – Parking Garage Luminaires

Specifications

Construction

Die-cast aluminum lower housing. Upper polycarbonate lens provides uplight, tapered shape of upper housing deters dirt accumulation, eases cleaning frequency, and deters birds from sitting or nesting. UV-resistant acrylic lower lens. Upper bracket and light engine frame are clear anodized aluminum.

IP Rating

IP66 rated luminaire with seal around entire perimeter of the lens.

LED Thermal management

The luminaire design provides excellent thermal management critical to long LED, driver and system life.

Light engine

Edge-lit, light guide technology provides low-glare, uniform illumination. Composed of 140 mid power LEDs. Color temperatures per ANSI/NEMA bin Warm White 3000K nominal (3045 +/- 175K), Neutral White 4000K nominal (3985 +/- 275K), or Cool White 5000K nominal (5029 +/- 283K). Minimum CRI of 70. 2700K 80CRI or 3500K 80CRI available – extended lead times apply, contact factory for details. LEDs tested by ISO 17025 accredited lab in accordance with IESNA LM-80 guidelines, extrapolations in accordance with IESNA TM-21.

Optical system

Type 1R Rectangular, Type 3 Asymmetric, Type 5 Symmetrical and Concentrated Downlight (CD) distributions available, designed for compliance to IES RP-20. Consider Type 1R for one luminaire per bay applications and ramps, Type 3 for wall mount applications and perimeter mounted luminaires to throw light into parking garage away from property line (LEED compliance, property cut-off, avoid light trespass), Type 5 for general use in parking bays, Concentrated Downlight and/or higher lumen configurations when enhanced lighting is required for entries and exits, ramps, payment areas, lobbies and waiting areas, etc. and for security lighting per IES G-1. Uplight (up to 4%) provided with Type 1R, Type 3 and Type 5 to eliminate cave effect, almost no uplight (<1%) available – extended lead times apply, contact factory for details. Almost no uplight (<1%) provided with Type CD. Light guide plate composed of high performance optical grade PMMA (polymethyl methacrylate) acrylic. Light guide technology allows for optimal light distribution without direct view of the LEDs, providing low-glare, uniform illumination and visual comfort. Performance tested per LM-63 and LM-79 (IESNA) certifying its photometric performance.

Electrical

UL Class 2 constant current driver. High power factor (0.9 minimum except 450mA at 277V or 480V = 0.75 minimum). 50/60 Hz. Low THD (20% maximum except 450mA at 277V or 480V >20%). Ambient temperature range: -40°C (-40°F) to +40°C (+104°F). Open/short circuit protection and voltage overload protection, automatic recovery after correction. Driver comes standard with 6KV on-board surge protection. Dimming driver standard. 0-10V dimming to minimum 10% power. RoHS compliant. Surge protector standard and tested in accordance with ANSI/IEEE C62.45 per ANSI/IEEE C62.41.2 Scenario I Category C High Exposure 10KV/5KA waveforms for Line-Ground, Line-Neutral and Neutral-Ground. Optional enhanced surge protector 20KV/10KA also available. When Emergency options **EBP** or **EBPC** are selected, two surge protectors are provided for complete protection – one for unswitched hot line and one for switched hot line.

Due to the inrush current that occurs with electronic drivers, recommend using a time delay or slow blow fuse to avoid unnecessary and unwanted fuse blowing that can occur with fast acting fuses.

Mounting

For Surface Mount (**SM**) option, a die formed 16 ga. galvanized steel plate is supplied for mounting to a recessed or surface-mounted 4" (10.16 cm) junction box (by others) – flush ceiling mount to a recessed junction box, or direct mount to a surface-mounted junction box. Integral hanger tabs on the plate support the luminaire during wiring. Single screw secures luminaire for quick and easy installation. Surface Mount (**SM**) includes minimum 36" of 16AWG wires that exit the luminaire. For pendant mounting, order Surface Mount (**SM**) and mount to a wet location junction box (by others) which you then direct mount onto rigid pendant (by others). Trunnion Mount (**TM**) option is designed to mount to a concrete ceiling with an anodized aluminum trunnion bracket assembly (order separate line item accessory, painted to match luminaire finish). Trunnion Mount (**TM**) includes SEOW cord that exits the luminaire. The assembly permits (8) one inch incremental mounting height adjustments, ranging from 13 to 21 inches. Wall Mount (**WM**) option is designed to anchor directly on a wall with wall bracket assembly (order separate line item accessory, painted to match luminaire finish), includes minimum 36" of 16AWG wires that exit the luminaire.

Controls

Motion Response luminaires (IMRI2 and IMRI3) include a passive infrared (PIR) motion sensor. Motion sensor standby power is 0.5 watts. In Motion Response luminaires, when no motion is detected for 10 minutes, the Motion Response system reduces the wattage by 80%, to 20% of the normal constant wattage per RP-20, reducing the light level accordingly. When motion is detected by the PIR, the luminaire returns to full wattage and full light output. Includes a daylight sensor which enables daylight harvesting. Wireless Remote Programming tool available (FSIR-100) for field programming (ordered separately).

Wireless controls also available, which combine the intelligence of motion and daylight sensing with wireless technology, allowing you to connect with your lighting system via the web.

Vibration resistance

Surface Mount (**SM**) 1.5G vibration rating conforms to the standards set forth by ANSI C136.31. Tested in all three axes, all performed on the same luminaire. When 3G is required, contact Quotations for modified mounting bracket (available upon request).

Emergency battery backup

Optional internal emergency battery pack immediately detects AC power loss then provides emergency light output for a minimum of 90 minutes when power is lost compliant with UL 924/CSA22.2 No. 141 and NFPA 101 Life Safety Code path of egress requirements. Integral so there is a consistent look between emergency and non-emergency luminaires, separate accessory box is not required. **EBP** suitable for use in ambient temperature conditions from 0°C (+32°F) to +40°C (+104°F). **EBPC** suitable for use in ambient temperatures from -20°C (-4°F) to +40°C (+104°F). **EBP** and **EBPC** are not available for use with **347V, 480V** or **HVU**. **EBP** and **EBPC** always include surge protection for both the switched and unswitched lines to ensure complete protection.

IK Rating

IK10 high impact resistance rating for both the upper lens and the lower lens.



SVPG SoftView LED

Garage & Canopy - Parking Garage Luminaires

Specifications (continued)

Finish

Each standard color luminaire receives a fade and abrasion resistant, electrostatically applied, thermally cured, triglycidyl isocyanurate (TGIC) textured polyester powdercoat finish on lower housing. Standard textured finishes include: **BZ** – Bronze Textured, **WH** – White Textured, **MGY** – Medium Gray Textured. Consult factory for specs on optional (OC) or custom (SC) colors. All exposed surfaces achieve a minimum of 1000 hours Salt Fog Test for corrosion in accordance with the ASTM B117 standard.

Hardware and Seals

All exposed screws shall be stainless steel and/or corrosion resistant and captive. All seals and sealing devices are made and/or lined with EPDM and/or silicone and/or rubber.

LED Products

Manufacturing Standard

The electronic components sensitive to electrostatic discharge (ESD) such as LEDs are assembled in compliance with EC61340-5-1 and ANSI/ESD S20.20 standards so as to eliminate ESD events that could decrease the useful life of the product.

LED Luminaire Useful Life

Accounts for LED lumen maintenance AND all of these additional factors including: LED life, driver life, PCB substrate, solder joints, on/off cycles, burning hours, and corrosion. Based on ISTMT in situ thermal testing in accordance with UL1598 and UL8750, LED LM-80/TM-21 data, driver lifetime data, and System Reliability Tool.

Listings

cULus Listed for Canada and U.S. to the UL 1598 standard, suitable for Wet Locations. Suitable for use in ambients from -40°C (-40°F) to +50°C (+122°F) up to 1675mA, to +40°C (+104°F) for 2100mA. The quality systems of the facility where manufactured have been registered by UL to the ISO 9001 series standards. Emergency Battery Backup options (EBP and EBPC) are tested and listed emergency lighting devices per UL 924 and CSA 22.2 No. 141. SoftView configurations are DesignLights Consortium qualified, consult DLC QPL Qualified Products List for more details.

Limited Warranty

5-year limited warranty. See signify.com/outdoorluminaires for complete details and exclusions.

LED Performance:

PREDICTED LUMEN DEPRECIATION DATA				
Ambient Temperature °C	System Current	Calculated L ₇₀ Hours ^{1,2}	L ₇₀ Per TM-21 ^{2,3}	Lumen Maintenance % @ 60,000 hours
25°C	up to 2100mA	>100,000	>60,000	83%

1. Predicted performance derived from LED manufacturer's data and engineering design estimates, based on IESNA LM-80 methodology. Actual experience may vary due to field application conditions.
2. L₇₀ is the predicted time when LED performance depreciates to 70% of initial lumen output.
3. Calculated per IESNA TM21-11. Published L₇₀ hours limited to 6 times actual LED test hours.

Optical Distributions

Based on 10' mounting height

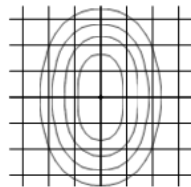

Type 1R

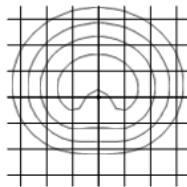

Type 3

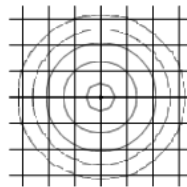

Type 5

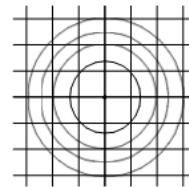

Type CD



© 2019 Signify Lighting Holding B.V. All rights reserved. Signify reserves the right to make changes in specifications and/or to discontinue any product at any time without notice or obligation and will not be liable for any consequences resulting from the use of this publication.

PGc-150653 SoftView SS - 12/18 - page 7 of 7

Signify Lighting, North America Corp.,
200 Franklin Square Drive,
Somerset, NJ 08873
Tel. 855-486-2216

Signify Lighting, Canada Ltd.,
281 Hillmount Rd, Markham, ON,
Canada L6C 2S3
Tel. 800-668-9008

www.gardcolighting.com



E4.e.
FOR PARKING GARAGES
LINEAR INTEGRAL LED

A. LED Fixture Specification

- i. Equal to BayLume extruded aluminum fixture with UV stabilized clean polycarbonate lens, Hi-Lo power option, surface / pendant mount, 5000K nominal CCT with ≥ 70 CRI, -40°C to $+40^{\circ}\text{C}$ operation, all test results to be provided. Mock-up is a must before any determination of installation.

ILLUMINA®

LED | WET | IP66 | IK05 LOGICA™ SANITATION TITLE 20 24 ENERGY STAR DLC RoHS

BS100LED

- The ILLUMINA® BS100LED is corrosion, flame and vandal resistant.
- **HOUSING:** 100% UV stabilized polycarbonate, liquid silicone perimeter gasket with memory retention.
- **DIFFUSER:** Frosted UV stabilized polycarbonate diffuser, providing even light distribution.
- **LUMENS:**

2FT	4FT
LO: 3585 up to 3796 lm	VLO: 3954 up to 4187 lm
MO: 4780 up to 5062 lm	LO: 5512 up to 5837 lm
HO: 5975 up to 6327 lm	MO: 6615 up to 7004 lm
	HO: 8366 up to 8857 lm
- **OPERATING TEMP:**

HT (AC Only) -40°F to 104°F (-40°C to 40°C)
SA (AC & Emergency) 32°F to 104°F (0°C to 40°C)
- **WEIGHT:** **2FT:** 5 lbs. / 2.2 kg. / **4FT:** 10 lbs. / 4.5 kg.



APPLICATION: The BS100LED is ideal for various applications including retail, industrial, parking, garages, carport, parking structures, warehouses, breezeways, canopies, schools, and much more. It can be installed both indoor and outdoor.

CONFIGURATIONS

MODEL	LENGTH	OPERATION	OUTPUT	COLOR TEMP	INPUT	MOUNTING	OPTIONS
BS100LED	2 (ft)	HT (AC only)	VLO ³	WT35 (3500K)	120-277V	SM ⁴ (surface mount)	SS (stainless steel clips)
BS100LED-RK ¹	4 (ft)	SA ² (AC & EM)	LO MO HO	WT40 (4000K) WT50 (5000K)	347V 480V	AC ⁵ (aviation cable) SPK ⁶ (single pendant kit) SVLSPK ⁶ (swivel single pendant kit) SVLDPK ⁶ (swivel double pendant kit) DPK ⁶ (double pendant kit) CH ⁹ (chain hang kit) TM ⁹ (trunion mount) PM (pivot mount) JM ⁷ (junction mount) MM ⁸ (magnet mount) QMB ⁹ (quick mount bracket)	FP (fuse protection - 3A) TPS ¹⁰ (tamper proof screws) TPB (tamper proof under driver bit) NDDL ¹¹ (integrated node - LOGICA) IOSL ¹¹ (internal occupancy sensor - LOGICA) EOSL ¹¹ (external occupancy sensor - LOGICA) IOS ¹² (internal occupancy sensor) IOSB ¹³ (internal bluetooth occ. sensor) EOS (external occupancy sensor) SP (surge protection - 10KA) B ¹⁴ (black housing) W ¹⁵ (white housing) D (dial) FA ¹⁶ (fully assembled)

NOTE 1: RK - Retro Fit Kit; Mounting options do not apply to BS100LED-RK unit.
NOTE 2: Title 20 emergency pack: 120/277V, 2FT: 10W, 1107 lumens; 4FT: 10W, 1135 lumens.
NOTE 3: VLO available for 4ft only.
NOTE 4: Surface mount is standard.
NOTE 5: Specify length for AC50°, 72°, 100°, 150°, 250° fully adjustable.
NOTE 6: SPK, DPK, CH, TM, & SVLSPK options must specify length.
NOTE 7: JM option - the unit is no longer well location, but dimm location.
NOTE 8: Magnetic mounts must be installed to steel beam measuring minimum 3/16" (4.7mm) thick.
NOTE 9: QMB must be used with JM.
NOTE 10: 18-8 stainless steel screws.
NOTE 11: Logica (Beggelli wireless and powerless control solutions). Contact factory for more details.
NOTE 12: FSP-221 requires wireless IR handheld remote (HHR-211) for changing defaults and testing of occupancy sensor. Order as needed (item #478100186). For more details, contact factory.
NOTE 13: Downloadable smart phone app for sensor configuration.
NOTE 14: Does not require MOO for 4ft.
NOTE 15: Contact factory.
NOTE 16: Includes latches and grommets installed at the factory. Can be combined with the JM option.

TECHNICAL INFORMATION

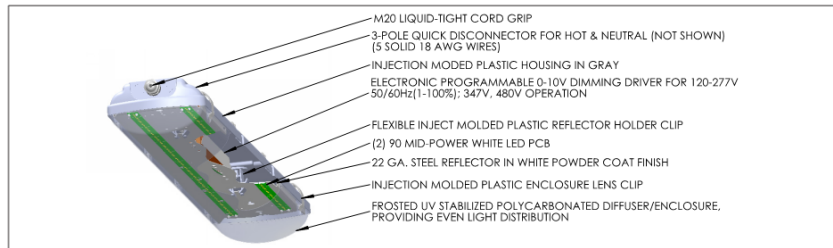

www.beggelliusa.com

7/25/19

Beggelli reserves the right to change, without notice, specifications or materials that in our opinion will not alter the function or performance of the product. Technical specifications that appear on www.beggelliusa.com supersede all other versions existing in print or electronic form.



DIMENSIONS

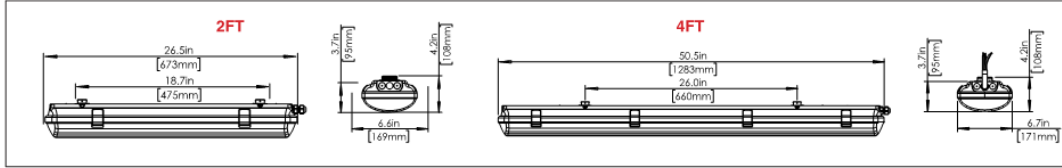

MOUNTING OPTIONS

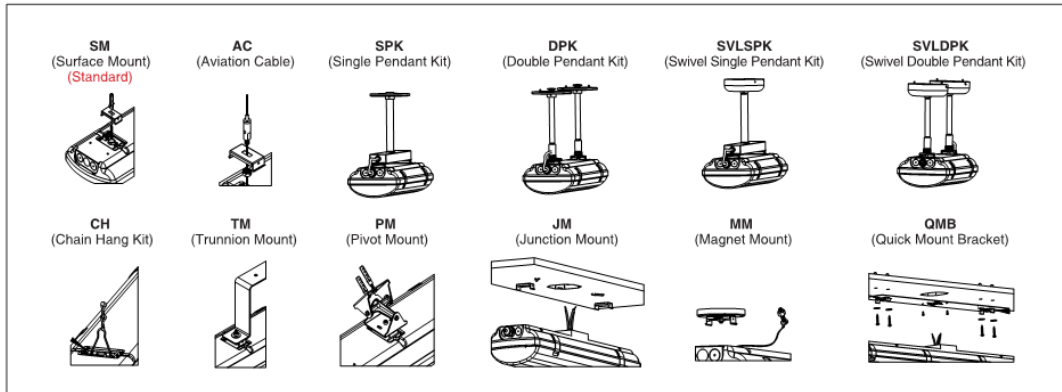

PHOTOMETRICS

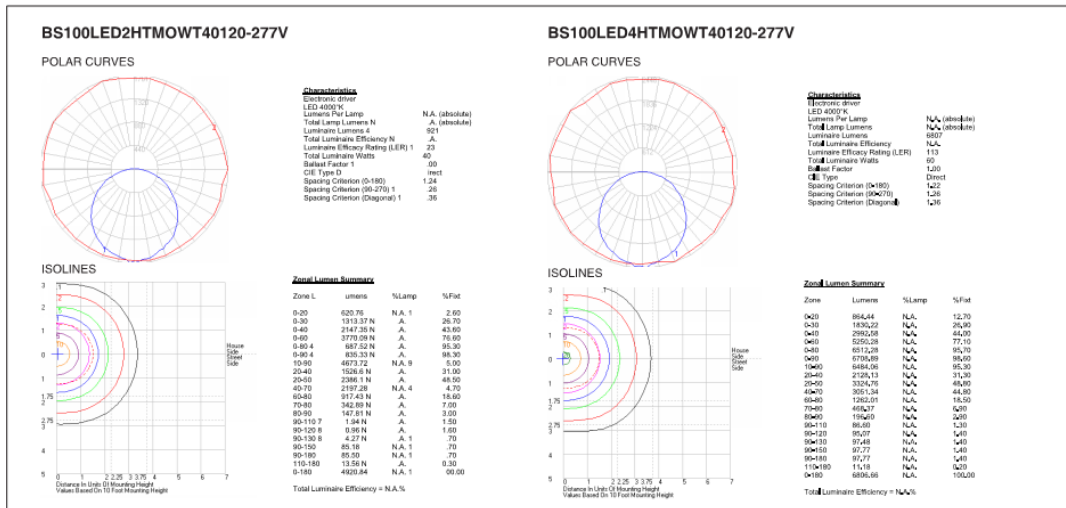

Beghelli reserves the right to change, without notice, specifications or materials that in our opinion will not alter the function or performance of the product. Technical specifications that appear on www.beghellusa.com supersede all other versions existing in print or electronic form.

7/25/19

www.beghellusa.com





ILLUMINA® BS100LED

ADDITIONAL INFORMATION

ENERGY CHART

MODEL	LENGTH	EFFICACY	CONSUMPTION WATTAGE	LUMEN OUTPUT	CRI	L70 (hrs.)	L85 (hrs.)
2FT							
BS100LED-2HT-LO-WT35-120-277V	2 ft	120 lm/W	30	3585	>80	>60,000	>50,000
BS100LED-2HT-LO-WT40-120-277V	2 ft	123 lm/W	30	3691	>80	>60,000	>50,000
BS100LED-2HT-LO-WT50-120-277V	2 ft	127 lm/W	30	3796	>80	>60,000	>50,000
BS100LED-2HT-MO-WT35-120-277V	2 ft	120 lm/W	40	4780	>80	>60,000	>50,000
BS100LED-2HT-MO-WT40-120-277V	2 ft	123 lm/W	40	4921	>80	>60,000	>50,000
BS100LED-2HT-MO-WT50-120-277V	2 ft	127 lm/W	40	5062	>80	>60,000	>50,000
BS100LED-2HT-HO-WT35-120-277V	2 ft	119 lm/W	50	5975	>80	>60,000	>50,000
BS100LED-2HT-HO-WT40-120-277V	2 ft	123 lm/W	50	6151	>80	>60,000	>50,000
BS100LED-2HT-HO-WT50-120-277V	2 ft	127 lm/W	50	6327	>80	>60,000	>50,000
4FT							
BS100LED-4HT-VLO-WT35-120-277V	4 ft	132 lm/W	30	3954	>80	>60,000	>50,000
BS100LED-4HT-VLO-WT40-120-277V	4 ft	136 lm/W	30	4070	>80	>60,000	>50,000
BS100LED-4HT-VLO-WT50-120-277V	4 ft	140 lm/W	30	4187	>80	>60,000	>50,000
BS100LED-4HT-LO-WT35-120-277V	4 ft	110 lm/W	50	5512	>80	>60,000	>50,000
BS100LED-4HT-LO-WT40-120-277V	4 ft	113 lm/W	50	5673	>80	>60,000	>50,000
BS100LED-4HT-LO-WT50-120-277V	4 ft	117 m/W	50	5837	>80	>60,000	>50,000
BS100LED-4HT-MO-WT35-120-277V	4 ft	110 lm/W	60	6615	>80	>60,000	>50,000
BS100LED-4HT-MO-WT40-120-277V	4 ft	113 lm/W	60	6807	>80	>60,000	>50,000
BS100LED-4HT-MO-WT50-120-277V	4 ft	117 lm/W	60	7004	>80	>60,000	>50,000
BS100LED-4HT-HO-WT35-120-277V	4 ft	120 lm/W	70	8366	>80	>60,000	>50,000
BS100LED-4HT-HO-WT40-120-277V	4 ft	123 lm/W	70	8610	>80	>60,000	>50,000
BS100LED-4HT-HO-WT50-120-277V	4 ft	127 lm/W	70	8857	>80	>60,000	>50,000

ELECTRICAL RATING

PRODUCT	NOMINAL POWER (W)	AC CURRENT (A)		FREQUENCY (HZ)	DC VOLTAGE (V)	DC CURRENT (MA)
		120V	277V			
2FT						
BS100LED-2HT-LO	30	0.26	0.12	50/60	44	600
BS100LED-2HT-MO	40	0.34	0.15	50/60	45	750
BS100LED-2HT-HO	50	0.43	0.18	50/60	45	1000
4FT						
BS100LED-4HT-VLO	30	0.25	0.11	50/60	43	600
BS100LED-4HT-LO	50	0.43	0.18	50/60	45	1000
BS100LED-4HT-MO	60	0.51	0.22	50/60	45	1200
BS100LED-4HT-HO	70	0.59	0.26	50/60	47	1400

DIMMER COMPATIBILITY

DIMMER	COMPATABILITY	
	ON / OFF	DIMMING
2FT		
LEVITON - AWRMG - 7	YES	YES
LUTRON - DIVA - DVSTV	YES	YES
LUTRON - DIVE - DVTV	YES	YES
WATT STOPPER - DCLV1	YES	YES
4FT		
LEVITON - AWRMG - 7	YES	YES
LUTRON - DIVA - DVSTV	YES	YES
LUTRON - DIVE - DVTV	YES	YES
WATT STOPPER - DCLV1	YES	YES



www.beghelliusa.com

7/25/19

Beghelli reserves the right to change, without notice, specifications or materials that in our opinion will not alter the function or performance of the product. Technical specifications that appear on www.beghelliusa.com supersede all other versions existing in print or electronic form.



LOGICA (WIRELESS & POWERLESS LIGHTING CONTROL SOLUTIONS)

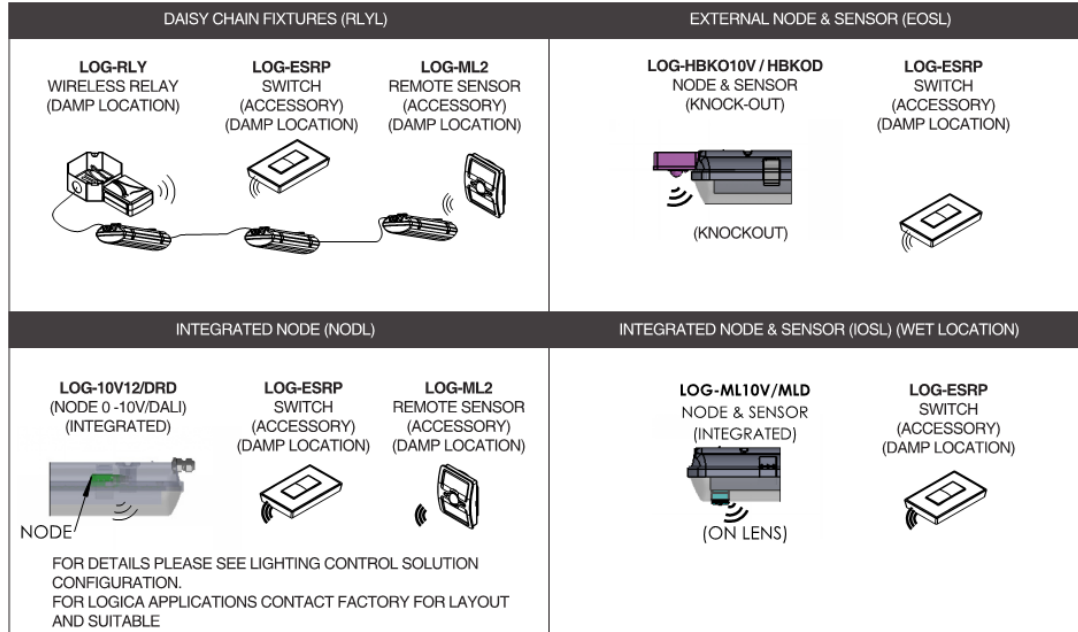

■ **WARRANTY:** 5 years, see website for full warranty details.



26 56 19 ROADWAY LIGHTING

1. GENERAL

- A. Related sections:
 - i. 26 56 00 – Exterior Lighting
 - ii. 26 56 13 – Lighting Poles and Standards
 - iii. 26 56 16 – Parking Lighting
- B. On roadways, fixture spacing shall be maximized without compromising the technical design criteria. Additionally, roadway poles shall be placed only on a single side of the street to light the street unless strictly required to comply with the technical design criteria.
- C. Roads
 - i. Collector (Intermediate Use) Roads
 - a. Collector roadways shall be designed for an average maintained illuminance value (E_{avg}) of 0.9 footcandle and shall maintain an average/minimum uniformity ratio not exceeding 4:1 (this means that if the average number of footcandles at the ground plane is 0.9, the minimum footcandle level shall not be lower than 0.23 footcandles). These values are in accordance with the IES Handbook, Ninth Edition.
 - ii. Arterial (Collector / Residential Use) Roads
 - a. Arterial roadways shall be designed for an average maintained illuminance value (E_{avg}) of 0.6 footcandles and shall maintain a uniformity ratio not to exceed 4:1 average / minimum. (This means that if the average number of footcandles at the ground plane is 0.6, the minimum footcandle level shall not be lower than 0.15 footcandles.) These values are in accordance with the IES Handbook, Ninth Edition.
 - iii. Local (Intermediate Use) Roads
 - a. Local roadways shall be designed for an average maintained illuminance value (E_{avg}) of 0.7 footcandles and shall maintain a uniformity ratio not to exceed 6:1 average/minimum. (This means that if the average number of footcandles at the ground plane is 0.6, the minimum footcandle level shall not be lower than 0.12 footcandles.) These values are in accordance with the IES Handbook, Ninth Edition.

2. PRODUCTS

- A. Refer to Section 26 56 13 Lighting Poles and Standards, and Section 26 56 16 Parking Lighting.



26 56 29
SITE & BUILDING ENTRY LIGHTING

1. GENERAL

A. Related sections:

- i. 26 56 00 – Exterior Lighting
- ii. 26 56 13 – Lighting Poles and Standards
- iii. 26 56 33 – Walkway Lighting
- iv. 26 56 36 – Flood Lighting

B. Building Entries: Lighting of building entrances provides a transition from a low exterior light level to much higher light levels inside while entering, and vice versa while exiting a building. As a rule, this lighting should follow criteria of exterior lighting discussed earlier, but with some alterations as described.

i. Primary Building Entry Lighting

- a. This shall be provided by using wall surface mount or wall recessed fixtures, and ceiling surface or recessed fixtures where they can be easily accessed and relamped. No fixture shall be mounted above the height of 20'-0" A.F.G. without prior approval from OUA.
- b. Decorative fixtures shall be used in these locations only if approved by OUA.
- c. An average maintained illuminance value (E_{avg}) of 3.0 footcandles and an average/minimum illuminance uniformity ratio of 3:1 measured at the ground plane will be provided within the footprint of the entrance area. If these fixtures also function as emergency egress lighting, ensure that the egress criteria given below and as per NFPA are met.

ii. Exterior Emergency Egress Lighting

- a. Emergency egress sources shall be mounted above the doors to minimize glare wherever possible. At secondary building entrances, a single LED fixture shall be centered directly above the door(s). Fixture selection must be approved by OUA.
- b. Provide an average maintained illuminance value (E_{avg}) of 1.0 footcandles and an average/minimum illuminance uniformity ratio of 10:1 measured at the ground plane. Lighting shall be designed to provide a minimum of 0.1 footcandle measured at the ground plane at a distance not less than 2 times the fixture mounting height and shall have IESNA full cutoff classification.

iii. Service Area Lighting

- a. These shall be designed to provide the necessary average illuminance levels required based on the specific task in accordance with the IES Handbook, Tenth Edition. The luminaires used should be provided with shielding accessories such as glare shield, louvers or barn doors to avoid glare. As far as possible, fixed wall/column mounted full cutoff type luminaires shall be used for area lighting and adjustable floodlights shall be avoided due to light pollution concerns.



2. **PRODUCTS**

- A. For Site and Building Entry – Series E1.
- B. Refer to Section 26 56 13 Lighting Poles and Standards; site lighting may be a mixture of light poles and building entry fixtures.
- C. See following product cutsheet for additional specification information on Series E1:
 - E2.a RAB Lighting LED Wallpacks – LED.



E2.a.
FOR BUILDING ENTRIES
LED WALLPACKS WITH LED LAMPING

A. Specification

- i. Equal to RAB Lighting LED Wallpack (10, 13, 20-Watt Options), IESNA Full Cutoff, Fully Shielded Optics, Mount at 11-20'
- ii. Black powdercoat finish; Design Professional to seek approval for finish color variance if placed on light color walls.

Created: 10/17/2012

WPLED10

10 Watt Surface mount or Junction Box LED Wallpack. Equivalent to 70W HPS. IESNA Full Cutoff, Fully Shielded optics. Mount at 7-10'. 5 year warranty.

Color: Bronze

Weight: 3.3 lbs

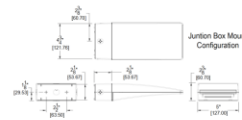

LED Info

Watts: 10W
Color Temp: 5000K (Cool)
Color Accuracy: 92
L70 Lifespan: 100000
LM79 Lumens: 547
Efficacy: 41 LPW

Driver Info

Type: Constant Current
120V: 0.21 A
208V: 0.14 A
240V: 0.12 A
277V: N/A
Input Watts: 13W
Efficiency: 76%

Technical Specifications

UL Listing:

Suitable for Wet Locations as a Downlight. Suitable for Damp Locations as an Uplight. Wall Mount only. Suitable for Mounting within 4ft. of ground.

Lumen Maintenance:

The LED will deliver 70% of its initial lumens at 100,000 hours of operation.

Finish:

Chip and fade resistant polyester powder coat finish.

Color Stability:

RAB LEDs exceed industry standards for chromatic stability.

Color Uniformity:

RAB's of CCT (Correlated color temperature) follows the guidelines of the American National Standard for Specifications for the Chromaticity of Solid State Lighting (SSL) Products, ANSI C78.377-2008.

Cold Weather Starting:

The minimum starting temperature is -40°F/-40°C

Ambient Temperature:

Suitable for use in 40°C (104°F) ambient temperatures

Fixture Efficacy:

41 Lumens per Watt

Color Accuracy:

92 CRI

Color Temperature (Nominal CCT):

5000K

Driver:

Multi-chip 10W high output long life LED Driver Constant Current, Class II, 120V-240V, 50/60 Hz, 350mA

Thermal Management:

Cast aluminum Thermal Management system for optimal heat sinking. The LPACK is designed for cool operation, most efficient output and maximum LED life by minimizing LED junction temperature.

Housing:

Precision die cast aluminum housing, lens frame.

Mounting:

Junction box.

California Title 24:

LPACK complies with California Title 24 building and electrical codes.

Green Technology:

RAB LEDs are Mercury, Arsenic and UV free.

Patents:

The LPACK design is protected under patents pending in the U.S., Canada, China, Taiwan and Mexico.

Dark Sky Approved:

The International Dark Sky Association has approved this product as a full cutoff, fully shielded luminaire.

For use on LEED Buildings:

IDA Dark Sky Approval means that this fixture can be used to achieve LEED Credits for Light Pollution Reduction.



Tech Help Line: 888 RAB-1000
Copyright ©2012 RAB Lighting, Inc. All Rights Reserved

Email: sales@rabweb.com

On the web at: www.rabweb.com

Note: Specifications are subject to change without notice

Page 1 of 2



WPLED13

13 Watt high performance LED Wallpack with 5 conduit entry points. Equivalent to 150W MH. Includes both junction box and surface mount for recessed box. IESNA Full Cutoff, Fully shielded optics. Mount at 11-20'. 5 year warranty.

Color: Bronze

Weight: 3.3 lbs

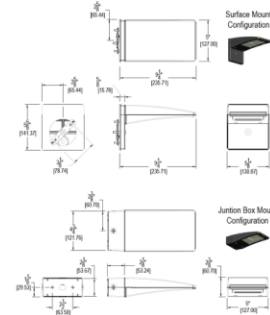

LED Info

Watts: 13W
Color Temp: 5000K (Cool)
Color Accuracy: 66
L70 Lifespan: 100000
LM79 Lumens: 1,064
Efficacy: 71 LPW

Driver Info

Type: Constant Current
120V: 0.13 A
208V: 0.08 A
240V: 0.07 A
277V: 0.06 A
Input Watts: 15W
Efficiency: 87%

Technical Specifications

UL Listing:

Suitable for Wet Locations as a Downlight. Suitable for Damp Locations as an Uplight. Wall Mount only. Suitable for Mounting within 4ft. of ground.

Lumen Maintenance:

The LED will deliver 70% of its initial lumens at 100,000 hours of operation.

Cold Weather Starting:

The minimum starting temperature is -40°F/-40°C

Ambient Temperature:

Suitable for use in 50°C (122°F) ambient temperatures

Driver:

Multi-chip 13W high output long life LED Driver
Constant Current, Class 2 100V - 277V, 50/60 Hz

Surge Protection:

4kv

Color Temperature (Nominal CCT):

5000K

Fixture Efficacy:

71 Lumens per Watt

Color Accuracy:

66 CRI

Finish:

Chip and fade resistant polyester powder coat finish.

Color Stability:

RAB LEDs exceed industry standards for chromatic stability.

Color Uniformity:

RAB's range of CCT (Correlated color temperature) follows the guidelines of the American National Standard for Specifications for the Chromaticity of Solid State Lighting (SSL) Products, ANSI C78.377-2008.

Green Technology:

RAB LEDs are Mercury and UV free.

Dark Sky Approved:

The International Dark Sky Association has approved this product as a full cutoff, fully shielded luminaire.

For use on LEED Buildings:

IDA Dark Sky Approval means that this fixture can be used to achieve LEED Credits for Light Pollution Reduction.

Patents:

The design of the LPACK is protected by U.S. Pat. D604,004 and patents pending in Canada, China and Taiwan.

IESNA LM-79 & IESNA LM-80 Testing:

RAB LED luminaires have been tested by an independent laboratory in accordance with IESNA LM-79 and 80, and have received the Department of Energy "Lighting Facts" label.

Gaskets:

High Temperature Silicone

Warranty:

RAB LED fixtures give you peace of mind because both the fixture and driver components are backed by RAB's 5 Year Warranty. For more information,





WPLED20

20 Watt LED Wallpack with 5 conduit entry points. Equivalent to 150W MH. Includes both junction box and surface mount for recessed box. IESNA Full Cutoff, Fully Shielded optics. Mount at 11-20'. 5 year warranty. UL Listed for up and down lighting.

Color: Bronze

Weight: 6.1 lbs

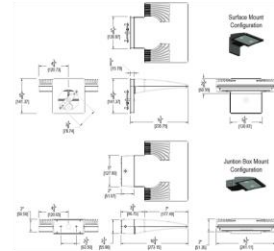

LED Info

Watts: 20W
Color Temp: 5000K (Cool)
Color Accuracy: 70
L70 Lifespan: 100000
LM79 Lumens: 1,401
Efficacy: 64 LPW

Driver Info

Type: Constant Current
120V: 0.19 A
208V: 0.12 A
240V: 0.10 A
277V: 0.08 A
Input Watts: 22W
Efficiency: 91%

Technical Specifications

UL Listing:

Suitable for wet locations. Suitable for mounting within 4' of the ground.

Lumen Maintenance:

100,000-hour LED lifespan based on IES LM-80 results and TM-21 calculations.

Cold Weather Starting:

The minimum starting temperature is -40°F/-40°C

Total Harmonic Distortion:

THD = 8.4%

Driver:

Two Multi-chip 10W high output long life LED Driver Constant Current, Class 2

Ambient Temperature:

Suitable for use in 50°C (122°F) ambient temperatures

Fixture Efficacy:

65 Lumens per Watt

Color Accuracy:

70 CRI

Color Temperature (Nominal CCT):

5000K (Daylight)

Thermal Management:

Integral cast aluminum mounting pad and external fins for optimal heat sinking to ensure cool operation with maximum LED life and light output.

Housing:

Precision die cast aluminum housing, lens frame and mounting plate.

Two Mounting Options:

Junction Box with 5 Conduit Entry Points and Threaded Plugs for surface mounting plus Cover Plate for mounting over 4" recessed junction box included with WPLED20

Finish:

Chip and fade resistant polyester powder coat finish.

Color Stability:

RAB LEDs exceed industry standards for chromatic stability.

Color Uniformity:

RAB's range of CCT (Correlated color temperature) follows the guidelines of the American National Standard for Specifications for the Chromaticity of Solid State Lighting (SSL) Products, ANSI C78.377-2008.

Green Technology:

RAB LEDs are Mercury, Arsenic and UV free.

Dark Sky Approved:

The International Dark Sky Association has approved this product as a full cutoff, fully shielded luminaire.

For use on LEED Buildings:

IDA Dark Sky Approval means that this fixture can be used to achieve LEED Credits for Light Pollution Reduction.

Patents:

The LPACK design is protected under patents pending in the U.S., Canada, China, Taiwan and Mexico.



Tech Help Line: 888 RAB-1000

Email: sales@rabweb.com

On the web at: www.rabweb.com

Copyright ©2012 RAB Lighting, Inc. All Rights Reserved

Note: Specifications are subject to change without notice

Page 1 of 2



26 56 33
WALKWAY LIGHTING

1. GENERAL

A. Related sections:

- i. 26 56 00 – Exterior Lighting
- ii. 26 56 13 – Lighting Poles and Standards
- iii. 26 56 29 – Site & Building Entry Lighting

B. Pedestrian Walkways / Bikeways (Adjacent To Roadways)

- i. Pedestrian walkways and bikeways adjacent to roads shall be designed for an average maintained illuminance value (E_{avg}) of 0.6 footcandle horizontal, and 1.1 footcandle vertical, as measured 6'- 0" above ground, and shall maintain an avg/min illuminance uniformity ratio not to exceed 4:1. (This means that if the average illuminance at the ground plane is 0.6 footcandles, the minimum illuminance shall not be lower than 0.15 footcandles.) These values are in accordance with the IES Handbook, Ninth Edition.

C. Pedestrian Walkways / Bikeways (Distant From Roadways)

- i. Pedestrian walkways distant from roads and bikeways adjacent to roads, a minimum average maintained horizontal illuminance value (E_{avg}) of 0.5 footcandles to identify obstacles on the pavement, and vertical illuminance of 0.5 footcandle measured 6'- 0" above ground, and shall maintain an average/min illuminance uniformity ratio not to exceed 5:1. (This means that if the average illuminance at the ground plane is 0.5 footcandles, the minimum illuminance level shall not be lower than 0.1 footcandles). Also important to security is a luminous environment, which extends out from the pavement and for a reasonable distance into the adjacent area. This extension should range at least six feet on either side of the pavement and have at least 1/3 of the value of the average illuminance level on the pavement. These values are in accordance with the IES Handbook, Ninth Edition.

D. UGA does not allow the use of lighted bollards.

2. PRODUCTS

- A. Refer to Section 26 56 13 Lighting Poles and Standards.



26 56 36
FLOOD LIGHTING

1. GENERAL

- A. Related sections:
 - i. 26 56 00 – Exterior Lighting
- B. Existing ground-based flood lighting of building facades shall be phased out and are not allowed on new construction projects. For renovations, these types of lights are to be replaced with wall-mounted, dark-sky friendly (full cutoff or fully shielded) fixtures (as approved) or fixtures placed at the base of the structure rather than in the landscape.